

MOUNTING SLOTS COMPATIBLE WITH
BREADBOARDS WITH 50mm OR 2in
HOLE SPACING

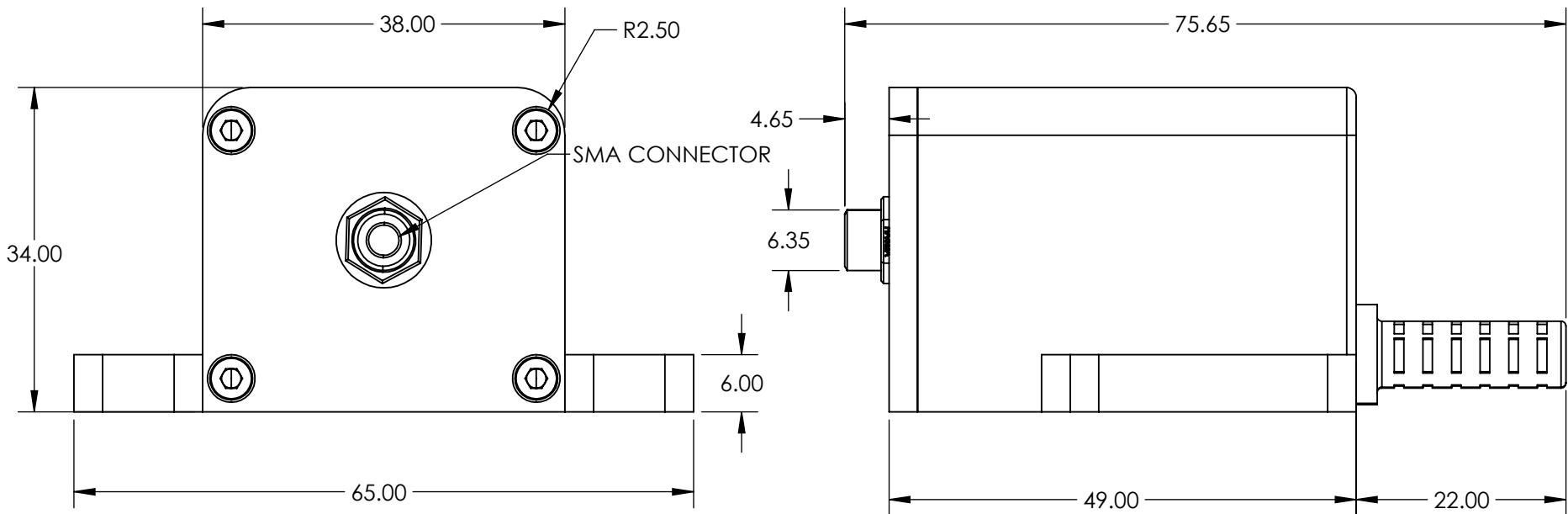
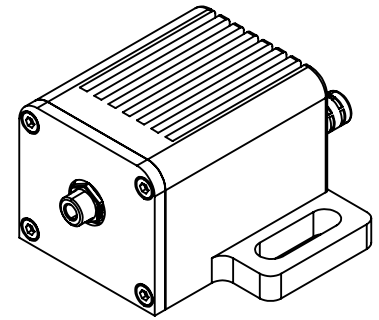

**FOR INFORMATION ONLY:
DO NOT MANUFACTURE
PARTS TO THIS DRAWING**

SPECIFICATIONS SUBJECT TO CHANGE WITHOUT NOTICE
DIMENSIONS ARE FOR REFERENCE ONLY

EO® Edmund Optics®

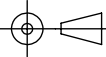
THIRD ANGLE PROJECTION 		TITLE	625nm, 5mW, 1000mA, SMA Connector, Fiber-Coupled LED	
ALL DIMS IN	mm	DWG NO	23737	SHEET 11 OF 18