



GIGE VISION CAMERAS

Alvium G1 User Guide

V1.1.2

FW 00.10.00.2cf3b22e

**Quick links**

- [Alvium G1 cameras at a glance](#) on page 14
- [Contact us](#) on page 16
- [Contents](#) on page 17

Read before use

EN - English

Safety

Before using the camera, read these safety instructions. Observe the warnings at all times. Use the camera only as stated in the [Intended use](#) on page 30.

**CAUTION****Risk of burns**

A camera in operation can reach temperature levels which could cause burns.

**CAUTION****Injury by falling cameras or lenses**

A falling camera or lens can cause injury.

**CAUTION****Risk of cuts by sharp edges of lens mounts**

The threads of the lens mount can have sharp edges.

Intended use

Intended use of Allied Vision product is the integration into vision systems by professionals. All Allied Vision product is sold in a B2B setting.

DA - Dansk

Sikkerhed

Læs sikkerhedsanvisningerne, før kameraet bruges. Overhold alle advarsler. Brug kun kameraet som anført i [Intended use](#) på side 30.



FORSIGTIG

Forbrændingsfare

Når kameraet bruges, kan det blive meget varmt og forårsage forbrændinger.



FORSIGTIG

Kvæstelser, hvis kameraet eller linser falder ned

Falder kameraet eller linsen ned, kan dette forårsage kvæstelser.



FORSIGTIG

Fare for snitsår på linsemodulets skarpe kanter

Linsemodulets gevind kan have skarpe kanter.

Tilsigtet brug

Allied Vision produktets tilsigtede brug er en indbygning i et visionssystem, udført af fagfolk. Alle Allied Vision produkter sælges i B2B.

DE - Deutsch

Sicherheit

Bevor Sie die Kamera benutzen, lesen Sie diese Sicherheitshinweise. Beachten Sie diese Hinweise immer. Verwenden Sie die Kamera nur wie beschrieben in [Intended use](#) auf Seite 30.



VORSICHT

Gefahr von Verbrennungen

Im Betrieb kann die Kamera Temperaturen erreichen, die zu Verbrennungen führen.



VORSICHT

Verletzung durch fallende Kameras oder Objektive

Eine fallende Kamera oder ein fallendes Objektiv kann Verletzungen verursachen.



VORSICHT

Schnitte durch scharfkantige Objektivgewinde

Objektivgewinde können scharfe Kanten haben.

Bestimmungsgemäßer Gebrauch

Allied Vision Produkte sind bestimmt für die Integration in Bildverarbeitungssysteme durch Fachpersonal. Alle Allied Vision Produkte werden in einer B2B-Umgebung verkauft.

ES - Español

Seguridad

Antes de utilizar la cámara lea estas instrucciones de seguridad. Observe las advertencias en todo momento. Utilice la cámara solo tal y como se estipula en el [Intended use](#) en la página 30.



ATENCIÓN

Riesgo de quemaduras

Una cámara en funcionamiento puede alcanzar temperaturas que podrían provocar quemaduras.



ATENCIÓN

Lesiones en caso de que las cámaras o las lentes se caigan

Si una cámara o una lente se cae puede provocar lesiones.



ATENCIÓN

Riesgo de cortes debido a los bordes afilados del objetivo

Las roscas de los objetivos pueden tener bordes afilados.

Uso previsto

El uso previsto del producto Allied Vision es la integración en el sistema de visión por parte de profesionales. Todos los productos Allied Vision se venden dentro de una relación B2B.

FI - Suomi

Turvallisuus

Lue nämä turvallisuusohjeet ennen kameran käyttöä. Noudata varoituksia joka hetki. Käytä kameraa ainoastaan kohdassa [Intended use](#) sivulla 30 kuvatulla tavalla.



HUOMIO

Palovammojen vaara

Käytössä olevan kameran saavuttamat lämpötilatasot voivat aiheuttaa palovammoja.



HUOMIO

Putoavien kameroiden tai linssien aiheuttamat vammat

Putoava kamera tai linssi voi aiheuttaa vammoja.



HUOMIO

Linssien kiinnikkeiden terävien reunojen aiheuttamien viiltovammojen vaara

Linssin kiinnikkeiden kierteiden reunat voivat olla teräviä.

Käyttötarkoitus

Allied Vision-tuotteen käyttötarkoitus on integrointi kuvajärjestelmiin ammattilaisten toimesta. Kaikki Allied Vision-tuotteet myydään B2B-ympäristössä.

FR - Français

Sécurité

Veillez lire ces consignes de sécurité avant d'utiliser la caméra. Respectez continuellement les avertissements. Utilisez la caméra uniquement comme indiqué sous [Intended use](#), page 30.



ATTENTION

Risque de brûlures

Une caméra en service peut atteindre des niveaux de température susceptibles d'entraîner des brûlures.



ATTENTION

Blessures en cas de chute de caméras ou d'objectifs

La chute d'une caméra ou d'un objectif peut entraîner des blessures.



ATTENTION

Risque de coupures sur les bords tranchants des montures d'objectif

Les filetages des montures d'objectif peuvent présenter des bords tranchants.

Utilisation prévue

L'utilisation prévue du produit Allied Vision est son intégration dans des systèmes de vision par le soin de professionnels. Tout produit Allied Vision est vendu dans un cadre B2B.

IT - Italiano

Sicurezza

Leggere queste istruzioni per la sicurezza prima di utilizzare la telecamera. Osservare sempre tutte le avvertenze. Utilizzare la telecamera come descritto alla sezione [Intended use](#) a pagina 30.



ATTENZIONE

Pericolo di ustioni

Durante il funzionamento una telecamera può raggiungere temperature elevate che possono essere causa di ustioni.



ATTENZIONE

Lesioni dovute alla caduta di telecamere o lenti

La caduta di una telecamera o di una lente può causare delle lesioni.



ATTENZIONE

Pericolo di tagliarsi sui bordi affilati degli attacchi della lente

I bordi della filettatura dell'attacco della lente possono essere affilati.

Uso previsto

Il prodotto Allied Vision è concepito per essere integrato in sistemi di monitoraggio in campo professionale. Tutti i prodotti Allied Vision sono venduti in uno scenario B2B.

JA - 日本語

安全性

本カメラを使用する前に、この安全の手引きをお読みください。常に、警告事項を守ってください。必ず、[Intended use 30](#) ページの通りに、本カメラを使用してください。



注意

やけどの危険性

作動中のカメラは、やけどを引き起こす温度まで熱くなる恐れがあります。



注意

カメラまたはレンズの落下によるけが

カメラまたはレンズが落下すると、けがをする恐れがあります。



注意

レンズマウントの鋭利な端部で切り傷の危険性

レンズマウントのギザギザの部分が鋭利である可能性があります。

用途

Allied Vision製品は、専門家が視覚装置に統合することを意図したものです。すべてのAllied Vision製品は、企業間取り引き用に販売されています。

NL - Nederlands

Veiligheid

Lees deze veiligheidsinstructies voordat u de camera gaat gebruiken. Neem deze waarschuwingen altijd in acht. Gebruik de camera uitsluitend, zoals aangegeven in het [Intended use](#) op pagina 30.



VOORZICHTIG

Risico van verbranding

Een camera die gebruikt wordt, kan temperatuurwaarden bereiken die brandwonden kunnen veroorzaken.



VOORZICHTIG

Letsel door vallende camera's of lenzen

Een vallende camera of lens kan letsel veroorzaken.



VOORZICHTIG

Risico van snijwonden door scherpe randen van lensbevestigingen

Het schroefdraad van de lensbevestiging kan scherpe randen hebben.

Beoogd gebruik

Het beoogde gebruik van het Allied Vision-product is de integratie in optische systemen door professionals. Alle Allied Vision-producten worden verkocht in de B2B-markt.

NO - Norsk

Sikkerhet

Les disse sikkerhetsinstruksene før du bruker kameraet. Følg advarslene til en hver tid. Bruk kun kameraet i samsvar med [Intended use](#) på side 30.



FORSIKTIG

Risiko for brannskader

Et kamera i bruk kan nå temperaturnivåer som kan forårsake brannskader.



FORSIKTIG

Skade ved fallende kameraer eller linser

Et fallende kamera eller en fallende linse kan forårsake skade.



FORSIKTIG

Risiko for kutt fra skarpe kanter på linsefester

Sporene på linsefestet kan ha skarpe kanter.

Tiltenkt bruk

Den tiltenkte bruken av Allied Vision-produktet er integrering i visjonssystemer av profesjonelle. Alle Allied Vision-produkter selges i en forretning til forretning-situasjon.

SV - Svenska

Säkerhet

Läs igenom säkerhetsinstruktionerna innan du använder kameran. Var hela tiden särskilt uppmärksam på varningarna. Använd enbart kameran på det sätt som anges i [Intended use](#) på sida 30.



VARNING

Risk för brännskada

En kamera i drift kan komma upp i temperaturer som kan orsaka brännskador.



VARNING

Risk för skador från fallande kameror eller objektiv

Fallande kameror eller objektiv kan förorsaka skador.



VARNING

Risk för skärsår från vassa kanter på objektivfattningar

Objektivets gängor kan ha vassa kanter.

Avsedd användning

Den avsedda användningen av Allied Vision-produkter är integrering i visionssystem av fackmän. Samtliga Allied Vision-produkter säljs i en B2B-miljö.

ZH - 简体中文版

安全需知

使用本相机前，请阅读本安全说明书。请务必遵守相关警告和 [Intended use](#) 于第 30 页。



注意事项

烫伤风险

相机操作过程中温度可能上升并导致烫伤风险。



注意事项

相机或者镜头跌落造成伤害

相机或者镜头可能会跌落并造成伤害。



注意事项

镜头接口的锐利边缘划伤风险

镜头接口螺纹边缘可能较为锐利。

预期用途

Allied Vision 产品的预期用途是由专业人士整合到视觉系统中。所有 Allied Vision 的产品均通过 B2B 渠道销售。

Alvium G1 cameras at a glance



Get an overview of Alvium G1 documentation:

Consider for Alvium G1 cameras	15
Specifications status.....	15
Shipping contents.....	15
What else do you need?	15

Consider for Alvium G1 cameras

For a smooth product experience, we suggest you to:

- Build up general knowledge: [Tips and tricks to connect 1000BASE-T](#) on page 143.
- Set up a quick running test: [Installing the camera](#) on page 112.
- Find solutions for issues: [Troubleshooting common issues](#) on page 157.

Specifications status

- Alvium G1-234 models will be released next.
- Alvium G1-510 models will be released later.

Shipping contents

- Alvium G1 camera
- Download Instructions for First Camera Operation document

What else do you need?

This is a selection of helpful downloads:

Download	Link
Alvium Cameras Features Reference Application notes	www.alliedvision.com/en/support/technical-documentation/alvium-gige-documentation
Vimba Suite for Windows, Linux, and Linux/ARM, including Vimba SDK , Vimba Viewer , and Vimba Driver Installer for Windows	www.alliedvision.com/software
Firmware downloads	www.alliedvision.com/en/support/firmware-downloads
STEP files	Find downloads for your Alvium model at www.alliedvision.com/en/camera-selector
Accessories , such as interface cables and cards, power and I/O cables, power supplies, lenses, and tripod adapters	www.alliedvision.com/en/support/accessory-documentation
Alvium Accessory Guide	www.alliedvision.com/en/support/technical-documentation/alvium-gige-documentation

Table 1: Downloads for Alvium G1 cameras

Contact us

Website, email

General

www.alliedvision.com/en/contact
info@alliedvision.com

Distribution partners

www.alliedvision.com/en/avt-locations/avt-distributors

Support

www.alliedvision.com/en/support
www.alliedvision.com/en/about-us/contact-us/technical-support-repair-/-rma

Offices

Europe, Middle East, and Africa (Headquarters)

Allied Vision Technologies GmbH
Taschenweg 2a
07646 Stadtroda, Germany
T// +49 36428 677-0 (Reception)
T// +49 36428 677-230 (Sales)
F// +49 36428 677-28

Asia-Pacific

China

Allied Vision Technologies
(Shanghai) Co., Ltd.
2-2109 Hongwell Int. Plaza
1602# ZhongShanXi Road
Shanghai 200235, China
T// +86 21 64861133

Singapore

Allied Vision Technologies Asia Pte. Ltd
82 Playfair Rd, #07-01 D'Lithium
Singapore 368001
T// +65 6634 9027

North, Central, and South America

Canada

Allied Vision Technologies Canada Inc.
300 – 4621 Canada Way
Burnaby, BC V5G 4X8, Canada
T// +1 604 875 8855

USA

Allied Vision Technologies, Inc.
102 Pickering Way- Suite 502
Exton, PA 19341, USA
Toll-free// +1-877-USA-1394
T// +1 978 225 2030

Contents

Read before use	2
EN - English	2
DA - Dansk	3
DE - Deutsch	4
ES - Español	5
FI - Suomi	6
FR - Français	7
IT - Italiano	8
JA - 日本語	9
NL - Nederlands	10
NO - Norsk	11
SV - Svenska	12
ZH - 简体中文版	13
Alvium G1 cameras at a glance	14
Consider for Alvium G1 cameras	15
Specifications status	15
Shipping contents	15
What else do you need?	15
Contact us	16
Document history and conventions	21
Document history	22
Conventions used in this user guide	24
Typographic styles	24
Symbols and notes	24
Acronyms and terms	25
Compliance, safety, and intended use	27
Camera identification	28
Compliance notifications	28
For customers in the US	28
For customers in Canada	29
Pour utilisateurs au Canada	29
Avoid electromagnetic interferences	29
Intended use	30
Copyright and trademarks	30
Your safety	31
Camera mounting	32
Product safety	33
Electrical connections	33
Optical components	35
Mechanical components	36

Specifications	37
Applied standards	38
GenICam	38
IP class	38
Shock and vibration	38
Notes on specifications	41
Sensor	41
Exposure time and frame rates	42
Operation for maximum frame rates	43
Triggering and sensor shutter types	44
Digital binning	45
Operation for typical power consumption	45
Dimensions and mass	45
Alvium G1 model specifications	46
Alvium G1-040m/c	46
Alvium G1-158m/c	49
Alvium G1-234m/c (coming soon)	52
Alvium G1-240m/c	55
Alvium G1-319m/c	58
Alvium G1-500m/c	61
Alvium G1-507m/c	64
Alvium G1-510m/c (coming soon)	67
Alvium G1-811m/c	70
Alvium G1-1236m/c	73
Alvium G1-1242m/c	76
Alvium G1-1620m/c	79
Alvium G1-2040m/c	82
Alvium G1-2050m/c	85
Alvium G1-2460m/c	88
White balance default	91
Dimensions and mass	92
Technical drawings	92
C-Mount	92
CS-Mount	93
S-Mount	94
Lens mounts and maximum protrusion	95
IR cut filter	96
Sensor position accuracy	97
Sensor shift and rotation	97
Sensor tilt	98
User sets	99
Supported features	99
Trigger features and UserSetDefault	99
Camera feature availability	100
Lenses: Focal length vs. field of view	102
About this chapter	103
Parameters in tables	103

Optical vignetting with certain lenses	103
About S-Mount lenses	104
Focal length versus field of view	104
Alvium G1-040m/c	104
Alvium G1-158m/c	105
Alvium G1-234m/c	105
Alvium G1-240m/c	106
Alvium G1-319m/c	106
Alvium G1-500m/c	107
Alvium G1-507m/c	107
Alvium G1-510m/c	108
Alvium G1-811m/c	108
Alvium G1-1236m/c	109
Alvium G1-1242m/c	109
Alvium G1-1620m/c	110
Alvium G1-2040m/c	110
Alvium G1-2050m/c	111
Alvium G1-2460m/c	111
Installing the camera	112
Touching hot cameras	113
Usage of heat sinks	113
Mounting the camera	114
Bottom or top mounting	114
Front mounting	115
Adapting maximum torque values	115
Mounting the lens	116
Mounting and focusing S-Mount lenses	117
Configuring the host computer	120
Installing the NIC driver	120
Modifying the NIC IP address	121
Adjusting the NIC driver settings	122
Connecting to the host computer	123
Allied Vision software	123
Third-party software	123
Powering up the camera	124
Powering the camera via I/O port	124
Powering the camera via PoE	124
Camera interfaces	125
I/Os: Precautions	126
Back panel	127
I/O connector pin assignment	128
I/Os and GPIOs	129
Isolated input description	129
I/O use for UART	129
Isolated output description	130
Non-isolated GPIOs description	132
Status LEDs	134

LED codes	134
Error state	134
Triggering and timings	135
Trigger signal flow	136
Trigger latency	136
Triggering with rolling shutter cameras	137
Ignored triggers	138
Trigger features and UserSetDefault	138
Image data flow	139
Firmware update	141
Firmware update with Vimba	141
Performance and troubleshooting	142
Tips and tricks to connect 1000BASE-T	143
Hardware selection	143
NIC hardware installation	143
NIC firmware and drivers	143
NIC driver settings	144
Operation system settings	145
Vimba TL settings	145
Optimizing performance	150
Image transfer with rolling shutter cameras	150
Frame rate jitter	150
Value changes by feature interdependencies	151
Dark current compensation	153
Shutter types affecting image readout	154
Operating systems and bandwidth	155
Troubleshooting common issues	157
Camera is not powered	157
Camera is not detected in the viewer	157
Camera cannot acquire images	158
Avoiding dropped packets	159
Index	160

Document history and conventions



This chapter includes:

Document history	22
Conventions used in this user guide.....	24
Acronyms and terms	25

Document history

Version	Date	Remarks
V1.1.2	2022-Aug-08	<ul style="list-style-type: none"> Removed data for Alvium G1-235 models from Alvium G1 model specifications on page 46 and Lenses: Focal length vs. field of view on page 102. Reverted change for the maximum gain of Sony IMX global shutter cameras in Alvium G1 model specifications on page 46 from 48 dB back to 24 dB.
V1.1.1	2022-Jul-22	Added values for minimum and maximum exposure times in Alvium G1 model specifications on page 46.
V1.1.0	2022-Jul-20	<p>Firmware version: 00.10.00.2cf3b22e</p> <ul style="list-style-type: none"> Replaced notes to inquire with Allied Vision Sales representatives by download links to the Allied Vision website. Removed notes for early production cameras from Consider for Alvium G1 cameras on page 15. Added G1-235m/c model in Alvium G1 model specifications on page 46 and in Lenses: Focal length vs. field of view on page 102. Updated data in Alvium G1 model specifications on page 46: <ul style="list-style-type: none"> Values for operating temperature ROI frame rates and exposure time ranges Maximum gain for Sony IMX global shutter cameras increased to 48 dB. Added new functionalities to Camera feature availability on page 100. Added I/O use for UART on page 129. Corrected description in Status LEDs on page 134. Added support for DPC and FPNC in Image data flow on page 139. Removed the sections “Feature validation status” and “Feature value changes on a streaming camera” from Performance and troubleshooting on page 142. Applied editorial changes.

Table 2: Document history

Version	Date	Remarks
V1.0.4	2022-Jun-08	<ul style="list-style-type: none"> Added Camera identification on page 28, including Model ID for DoC assignment. Replaced calculated values for power consumption in Alvium G1 model specifications on page 46 by measured values. Updated data for Alvium G1-234m/c in Alvium G1 model specifications on page 46. Added warning against voltage levels of serial communication and wrong polarity of external power in I/Os: Precautions on page 126. Applied editorial changes.
V1.0.3	2022-May-19	<ul style="list-style-type: none"> Rounded values in Dimensions and mass on page 92 from 62 g to 65 g in order to match conventions for Alvium cameras. Adapted descriptions in Table 70: TFM I/O connector pin assignment on page 128 to ease the comparison with previous Allied Vision GigE cameras. Applied editorial changes.
V1.0.2	2022-May-09	Added advice in ESD on page 33.
V1.0.1	2022-Apr-28	<ul style="list-style-type: none"> Reversed maximum operation temperature in Alvium G1 model specifications on page 46 from concreted values to “tbd”. Added notes against material damage for GPIOs with PoE power in I/Os and GPIOs on page 129. Added Tips and tricks to connect 1000BASE-T on page 143. Applied editorial changes.
V1.0.0	2022-Apr-12	Firmware version: 00.09.00.e23cb4e8 Release version

Table 2: Document history

Conventions used in this user guide

To give this manual an easily understood layout and to emphasize important information, the following typographical styles and symbols are used.

Typographic styles

Style (example)	Function
Emphasis	Programs, or highlighting important things
Feature names	GenlCam features names
<i>Feature options</i>	Features options and register's options that are selectable by the user
UI Element	Text that is displayed, or output, by the system for the user, like parts of the GUI, dialog boxes, buttons, menus, important information, windows titles.
Reference	Links to webpages and internal cross references

Table 3: Typographic styles

Symbols and notes



CAUTION

Risk of burns

Precautions are described



CAUTION

Injury by falling cameras or lenses

Precautions are described



CAUTION

Risk of cuts by sharp edges of lens mounts

Precautions are described



NOTICE

Material damage or violation of data security

Precautions are described.

Practical Tip

Additional information helps to understand or ease handling the camera.

Avoiding malfunctions

Precautions are described.

Additional information

Web link or reference to an external source with more information is shown.

Acronyms and terms

The following table provides a list of acronyms and terms used in this document.

Acronym or term	Description
ADC	Analog to Digital Converter
AIA	Automated Imaging Association
CRA	Chief ray angle
EMVA	European Machine Vision Association
ERS	Electronic rolling shutter also known as “rolling shutter”
ESD	Electrostatic Discharge
FCC	Federal Communications Commission
FOV	Field of view
FPNC	Fixed pattern noise correction
fps	Frames per second
Gbps	Gigabit per second
GenICam	Generic Interface for Cameras, EMVA
GND	Ground (power)
GPIOs	General purpose inputs and outputs (non-isolated)
GRRS	Global reset release shutter, see GRS
GRS	Global reset shutter, see GRRS
GS	Global shutter
H × V	Horizontal × Vertical (sensor resolution)
KB	Kilobyte
MBps	Megabytes per second
MP	Megapixels (see P)

Table 4: Acronyms and terms (sheet 1 of 2)

Acronym or term	Description
N.a.	Not applicable (in tables)
NIC	Network interface card
P	Pixels (see MP)
PSE	Power sourcing equipment
QE	Quantum efficiency
RoHS	Restriction of Hazardous Substances Directive
ROI	Region of interest
RS	Rolling shutter
SFNC	Standard Feature Naming Convention (GenICam)
shutter mode	Value of the ShutterMode feature to select between rolling shutter (RS) and global release shutter (GRS)
shutter type	Sensor specific readout, such as rolling shutter (RS) or global shutter (GS)
S-Mount	M12-Mount

Table 4: Acronyms and terms (sheet 2 of 2)

Compliance, safety, and intended use



This chapter includes:

Camera identification.....	28
Compliance notifications	28
Intended use	30
Copyright and trademarks	30
Your safety.....	31
Product safety	33

Camera identification

You can identify your Alvium G1 camera like this:

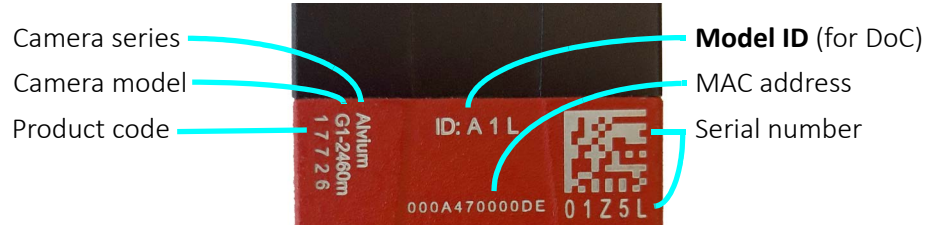

Closed housing Alvium G1 cameras have the Model ID: **A 1 L**.

Compliance notifications



National regulations on disposal must be followed.

For customers in the US



Class B digital device

This equipment has been tested and found to comply with the limits for a Class B digital device, pursuant to part 15 of the FCC Rules. These limits are designed to provide reasonable protection against harmful interference in a residential installation. This equipment generates, uses and can radiate radio frequency energy and, if not installed and used in accordance with the instructions, may cause harmful interference to radio communications. However, there is no guarantee that interference will not occur in a particular installation. If this equipment does cause harmful interference to radio or television reception, which can be determined by turning the equipment off and on, the user is encouraged to try to correct the interference by one or more of the following measures:

- Reorient or relocate the receiving antenna.
- Increase the separation between the equipment and receiver.
- Connect the equipment into an outlet on a circuit different from that to which the receiver is connected.
- Consult the dealer or an experienced radio/TV technician for help.

Supplier Declaration of Conformity

Alvium G1 cameras comply with Part 15 of the FCC Rules. Operation is subject to the following two conditions:

1. This device may not cause harmful interference, and
2. This device must accept any interference received, including interference that may cause undesired operation.

Party issuing Supplier's Declaration of Conformity

Allied Vision Technologies GmbH
Taschenweg 2a
07646 Stadtroda, Germany
T// +49 (36428) 677-106
quality@alliedvision.com

Responsible party - US contact information

Allied Vision Technologies, Inc.
102 Pickering Way – Suite 502
Exton, PA 19341, USA
T// +1 978 225 2030

Note: changes or modifications not expressly approved by the party responsible for compliance could void the user's authority to operate the equipment.

For customers in Canada

This apparatus complies with the Class B limits for radio noise emissions set out in the Radio Interference Regulations.

CAN ICES-3 (B) / NMB-3 (B)

Pour utilisateurs au Canada

Cet appareil est conforme aux normes classe B pour bruits radioélectriques, spécifiées dans le Règlement sur le brouillage radioélectrique.

CAN ICES-3 (B) / NMB-3 (B)

Avoid electromagnetic interferences

Interface cables, power cables, and I/O cables are sensitive to electromagnetic interference.

- Use shielded cables only.
- We recommend using cables offered by Allied Vision.
- Avoid coiling.
- We recommend using GPIOs only in environments with low electromagnetic interference.

Moreover, avoid unnecessary bending to prevent damage to the cables.

Intended use

Allied Vision's objective is the development, design, production, maintenance, servicing and distribution of digital cameras and components for image processing. We are offering standard products as well as customized solutions.

Intended use of Allied Vision product is the integration into Vision systems by professionals. All Allied Vision product is sold in a B2B setting.

Allied Vision isn't a legal manufacturer of medical product. Instead, Allied Vision cameras and accessories may be used as components for medical product after design-in by the medical device manufacturer and based on a quality assurance agreement (QAA) between Allied Vision (supplier) and medical device manufacturer (customer). Allied Vision's duties in that respect are defined by ISO 13485, clause 7.2 (customer-related processes, equivalent to ISO 9001, clause 8.2).

Copyright and trademarks

All text, pictures, and graphics are protected by copyright and other laws protecting intellectual property. All content is subject to change without notice.

All trademarks, logos, and brands cited in this document are property and/or copyright material of their respective owners. Use of these trademarks, logos, and brands does not imply endorsement.

Copyright © 2022 Allied Vision GmbH. All rights reserved.

Your safety

This section informs about issues related to your personal safety. Descriptions explain how to avoid hazards and operate Alvium G1 cameras safely.

Handling lens mounts

The lens mount thread has sharp edges. Be careful these edges do not cut your skin when mounting or unmounting lenses.

Handling hot cameras

Depending on the individual setup, Alvium G1 cameras can exceed the specified maximum operating temperature. In many cases, mounting the camera on a metal surface or using a lens will be sufficient to cool the camera effectively. However, especially when operated in higher ambient temperatures, additional measures for heat dissipation, such as using a heat sink, should be considered.

If you have doubts or questions, please feel free to contact your Allied Vision Sales representative for support!

If the mainboard temperature exceeds the specified maximum for more than two seconds, the camera is powered off automatically. The current value for mainboard temperature is output by `DeviceTemperature`. You can use this value to control cooling by software, for example, to control a fan.

However, if you hold the camera in your hands during operation, your skin may get hurt. If you touch the camera when it is heated up, we recommend wearing protective gloves.

Providing optimum heat dissipation

Keep the operating temperature in the specified range to enable best image quality and to protect the camera from damage.

For your safety and to improve image quality, we recommend operating the camera:

- Mounted to a base with a high thermal conductivity
- With lens or other optical components mounted
- With a heat sink mounted that has large surface areas
- Using conductive media for camera and heat sink mounting
- With active cooling of camera, mounting base, and heat sink, such as by ventilation.
- Reduce high ambient temperature. For example, in outdoor applications with direct sunlight, provide shading by an enclosure.

Camera mounting

Cameras must be mounted using the mounting threads. If vibration is higher than specified, cameras can disconnect from the mounting. Falling cameras can hurt you. To avoid personal injury:

- Mount the camera according to the instructions in [Mounting the camera](#) on page 114.
- Ensure, shock and vibration do not exceed the specified range, see [Shock and vibration](#) on page 38.
- Use a lens support if you want to use [Heavy lenses](#).

Heavy lenses

For non-static applications, use lenses with a mass less than 140 grams and a length less than 38 mm, where the center of gravity is 20 mm, measured from the lens mount front flange. For heavier or longer lenses, use a lens support and apply additional tests. For more information, please contact support at www.alliedvision.com/en/about-us/contact-us/technical-support-repair-/-rma.



Applied mechanical tests

See [Shock and vibration](#) on page 38 for standards compliance.

Product safety

To prevent material damage, read the following and understand how to safely handle and operate the camera. Get helpful details about electrical connections and learn how to optimize camera performance.

Electrical connections

ESD

ESD is dangerous for electronic devices, especially when tools or hands get in contact with connectors and electronic components. We recommend measures to avoid damage by ESD:

- **Unpacking:** Remove the camera from its anti-static packaging only when your body is grounded.
- **Workplace:** Use a static-safe workplace with static-dissipative mat and air ionization.
- **Wrist strap:** Wear a static-dissipative wrist strap to ground your body.
- **Clothing:** Wear ESD clothing. Keep components away from your body and clothing. Even if you are wearing a wrist strap, your body is grounded but your clothes are not.
- **Screw-locks:** Tighten screw locks of all cabling prior powering the camera. Do not touch locking screws during operation to prevent camera malfunction.

Cable connections

Provide sufficient strain relief for all cable connections to avoid short circuits and malfunctions.

Camera power

Operating the camera beyond the specified range damages the camera.

Cameras can be powered using the I/O connector at an input range of 12 to 24 VDC, using a limited power source (LPS), according to IEC 62368-1 with maximum 2.0 A. The camera is not intended to be connected to a DC distribution network.

Alternatively, cameras can be powered over Ethernet. However, power consumption and heat generation are higher than with external power, using the I/O connector.

- Make sure that PoE power sourcing equipment is at least compliant to IEEE 802.3af.
- Only use power supplies that meet the insulation requirement according to PELV or SELV. For details, please refer to IEC 61140.
- If using external power supplies by third-party manufacturers, observe polarity to avoid damage to the camera electronics.



PoE versus external power

Powering the camera via PoE results in higher power consumption and heat generation than external power, resulting in higher energy costs and requiring more efficient heat dissipation.



External power supply

For the 13870 10-pin TFM power supply, see www.alliedvision.com/en/support/accessory-documentation.

I/Os

To avoid damage to the camera, keep the maximum values for

- Isolated I/Os: Input voltage below 24 VDC, output current below 20 mA per output.
- Non-isolated GPIOs: Input voltage below 5.5 VDC, output current below 12 mA.

See [Alvium G1 model specifications](#) on page 46 for details. The maximum length for I/O cables must not exceed 30 meters.



Power supply via I/O cables

If you power the camera via an I/O cable, consider the voltage drop to meet the minimum supply voltage for the camera.

I/Os and power supply by PoE

The PoE implementation is non-isolated. Therefore, when the camera is powered by PoE:

- Only connect the pins 3, 4, 5, 6 and 10 (isolated I/Os) of the TFM connector.
- **Do not** connect any other pins of the TFM connector.

See [Camera interfaces](#) on page 125 for details.

GigE connection

GigE NICs

To avoid damage to GigE NICs and injectors, make sure that PoE power sourcing equipment is at least compliant to IEEE 802.3af.



GigE accessories

For GigE interface cables, NICs, switches, and more, see www.alliedvision.com/en/support/accessory-documentation.

Ethernet cables

Proper cable handling enables reliable performance:

- We recommend Category 6 (CAT6) or higher rated Ethernet cables for Alvium G1 cameras. A different rating may not sustain peak interface bandwidth; leading to lost connectivity or dropped frames coming from the camera. .
- Use only shielded cables to avoid electromagnetic interferences.
- Please use cables recommended by Allied Vision.
- Avoid unnecessary bending to prevent damage to the cables.
- Avoid coiling to prevent electromagnetic interference.

Optical components

Provide the following conditions to keep dirt and droplets out of the optical system of camera and lens:

- Dust-free environment
- Low relative humidity
- No condensation.

When camera or lens are stored:

- Cover the lens mount with a protection foil or cap.
- Cover front and back lens with caps.

Sensor

Sensors are sensitive to excessive radiation: focused sunlight, lasers, and X-rays can damage the sensor. Dirt and scratches can damage the sensor as well.

Alvium G1 cameras do not need additional cleaning. Cameras are cleaned before shipping. Incorrect cleaning can damage the sensor or the filter. Therefore, never clean the sensor or the filter.

Protect the camera filter and the sensor from dirt, because dirt becomes more visible the closer it gets to the sensor. In addition, keep the back lens clean. Hold the camera with the lens mount facing the ground to keep dirt out of the lens mount. When no lens is mounted, protect the sensor and filter by a dust cap.

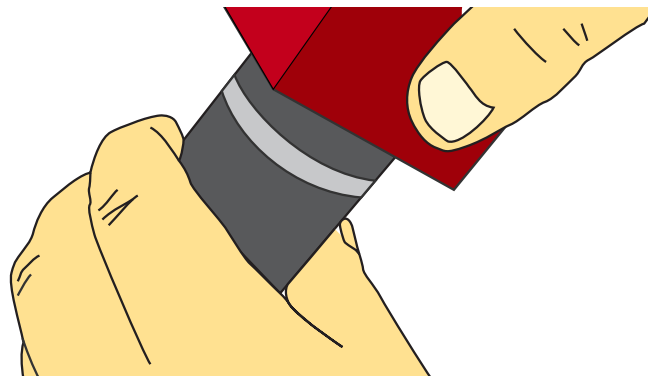

Figure 1: Holding the camera with the lens mount facing the ground

Lenses

Maximum protrusion

The sensor, filter, or lens can be damaged if a lens exceeding maximum protrusion is mounted to the camera. Use lenses with a maximum protrusion within camera specifications. [Figure 2](#) shows schematics for maximum protrusion. For details, see [Lens mounts and maximum protrusion](#) on page 95.

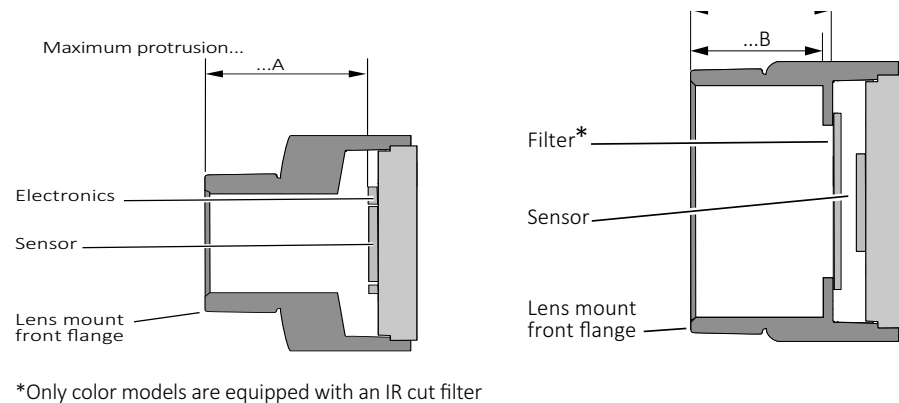

Figure 2: Maximum protrusion S-Mount (left); CS-Mount and C-Mount (right)

For S-Mount lenses, read [Mounting and focusing S-Mount lenses](#) on page 117 to avoid damage to the sensor, the electronics, and lens.

Mechanical components

Heat sinks

Heat sinks can be used to cool the camera for safety and to improve image quality. Adhere to the instructions provided by the manufacturer of the heat sink.

Conductive media

Some conductive media for heat sinks contain corrosive substances that can damage optical surfaces of the sensor, filter, and lens.

- Cover the optical path of the camera when you apply heat sink compound or adhesive to prevent substances and fumes from damaging optical surfaces.
- Adhere to the instructions and safety notes provided by the manufacturer of the conductive media.
- Ensure that the conductive media is correctly positioned: covering only the components to be cooled.

Specifications



This chapter includes:

Applied standards	38
Notes on specifications	41
Alvium G1 model specifications.....	46
White balance default.....	91
Dimensions and mass	92
Technical drawings	92
Lens mounts and maximum protrusion	95
IR cut filter.....	96
Sensor position accuracy	97
User sets.....	99
Camera feature availability	100

Applied standards

GenICam

GenICam provides a generic access to cameras and devices that is independent of the interface. This enables operating cameras with USB3 Vision, GigE Vision, or CoaXPress interfaces with a common software.

GenICam consists of multiple modules for different tasks. Allied Vision cameras and software use these modules, such as the SFNC that standardizes feature names and types via an XML file.

Alvium G1 cameras comply to:

- GigE Vision Standard Version 1.2
- GenICam Standard Document Version 2.1.1
- GenAPI Schema Version 1.1
- GenICam Standard Features Naming Convention (SFNC) Version 2.4
- GenICam Pixel Format Naming Convention (PFNC) Version 2.2

GigE Vision

The GigE Vision standard specifies a UDP based protocol for machine vision and imaging products. It provides control over compliant devices by GenICam Applications Programming Interface (API). The GigE Vision standard is administered by the Automated Imaging Association (AIA).

IP class

Equipped with a lens as intended, Alvium G1 cameras comply with IP30 class according to IEC 60529.

Shock and vibration

Alvium G1 cameras were tested successfully according to the following standards:

- IEC 60068-2-6, sinusoidal vibration testing
- IEC 60068-2-27, shock testing
- IEC 60068-2-64, random vibration testing.

Cameras were inspected before and after the tests. All tests were passed successfully:

Condition	Passed
Mechanics	<ul style="list-style-type: none"> The camera housings showed no deformations. The connections between camera components had not come loose. The sensor position was within the specified tolerances of a new camera.
Camera behavior	Camera functionalities were not affected, no deviations occurred.
Image streaming	Images were streamed without errors.

Table 5: Conditions for passed tests

The conditions for cameras and lenses were the same for all tests. Solid aluminum tubes were used to represent real lenses:

Parameter	Value
Lens dummy length	22 mm
Lens dummy mass	70 g
Center of gravity (CoG) ¹	17 mm

¹For camera and lens dummy assemblies, measured from the lens mount front flange

Table 6: Conditions for lenses

IEC 60068-2-6: Sinusoidal vibration

Frequency	Acceleration	Displacement
10 Hz to 58.1 Hz	Not applicable	1.5 mm
58.1 Hz to 500 Hz	20 g	Not applicable

Table 7: Frequency, acceleration, and displacement for IEC 60068-6 tests

Parameter	Value
Axis ¹	x, y, z
Sweep rate	1 oct/min
Sweep duration per axis [hh:mm:ss]	03:45:40
Number of sweeps	10

¹For technical reasons, all three axes are tested with the shaker in the upright position without a sliding table.

Table 8: Other parameters for IEC 60068-6 tests

IEC 60068-2-27: Shock

Parameter	Value
Axis	x, y, z
Acceleration	20 g
Number of shocks per axis	10
Duration per axis	11 ms
Waveform	Half sine

Table 9: Parameters for IEC 60068-2-27 tests

IEC 60068-2-64: Random vibration

Frequency	Acceleration
15 Hz to 500 Hz	0.05 g ² /Hz

Table 10: Frequency and acceleration for IEC 60068-2-64 tests

Parameter	Value
Axis	x, y, z
Acceleration RMS (Sigma)	4.9 g
Acceleration peak (Sigma)	14.8 g
Duration per axis [hh:mm:ss]	00:30:00

Table 11: Other parameters for IEC 60068-64 tests

Notes on specifications

This section defines the conditions for specifications stated in this chapter.

Sensor

Absolute QE plots

Measurements for color cameras were done with IR cut filter. Measurements for monochrome and S-Mount cameras were done without optical filters. With protection glass or filters, QE decreases by approximately 10 percent.

The uncertainty in measurement of the QE values is ± 10 percent. This is mainly due to uncertainties in the measuring apparatus itself (such as Ulbricht sphere and optometer).

Manufacturing tolerance of the sensor increases overall uncertainty.

ON Semiconductor sensors

The curve in the absolute QE plots shown in this chapter is taken from the sensor manufacturer data sheet. The information was correct at the time of publishing.

Sony sensors

Sony provides relative response curves in their sensor data sheets. To create the absolute QE plots shown in this chapter, the relative response was converted to a normalized QE response and then adjusted as per three measured QE values (at 448 nm, 529 nm, 632 nm) for color sensors and one measured QE value (at 529 nm) for monochrome sensors.

Wavelength

The wavelength range in the absolute QE plots reflects the information available in the sensor manufacturer data sheet at the time of publishing. Many color sensors are documented by the sensor manufacturer only for wavelengths from 400 nm to 700 nm.

Spectral response plots

The curves in the spectral response plots shown in this chapter were calculated from measured quantum efficiencies at 448 nm, 529 nm, and 632 nm. The shape of the curve is taken from the sensor data sheet, but the values have been adjusted based on these measured values. The uncertainty in measurement of the spectral response values is ± 10 percent.

Exposure time and frame rates

Specified values

Stated values were calculated (see [Operation for maximum frame rates](#)). Not all values were confirmed by testing. Minor deviations may occur.

Factors for exposure time and frame rates

- The **default bandwidth** for Alvium G1 cameras is 115 MBps. For some models, you can achieve higher frame rates by increasing values for **DeviceLinkThroughputLimit**. See [Operating systems and bandwidth](#) on page 155.
- Available values and increments for **exposure time** depend on other controls, such as **DeviceLinkThroughputLimit**. See [Value changes by feature interdependencies](#) on page 151.
- For **delays**, see [Exposure start delay = exposure area – exposure time](#). on page 137.
- Calculation of maximum **frame rates for different ROIs** for Alvium G1 cameras does not allow to give a formula. [Operation for maximum frame rates](#) on page 43 defines the conditions for measuring ROI frame rates.

Sensor ADC readout modes for maximum frame rates

If you are using pixel formats that do not require 12-bit sensor ADC readout and you want to achieve higher frame rates, you can select between readout modes for 12-bit, 10-bit, and 8-bit with some Alvium G1 camera models. See your model's specifications.

By default, Alvium G1 models use the maximum bit depth for **SensorBitdepth**. For selected models, **Adaptive** mode switches automatically between 12-bit and 10-bit sensor ADC readout, depending on the bit depth of the selected pixel format. This allows to reduce bandwidth and increase frame rates when only 10-bit is required.

To enable the 8-bit sensor readout mode, you must switch manually, using **SensorBitdepth**. Please observe that the image brightness changes when you switch between 8-bit sensor ADC readout mode and the other readout modes.

Exposure time behavior regarding ExposureMode

This section informs about how exposure time behaves in the different exposure modes. All Alvium cameras have an exposure time offset. The exposure time offset and the exposure time increment depend on sensor and camera characteristics. Both, the exposure time offset and the exposure time increment, can change if **Width**, **PixelFormat**, or **DeviceLinkThroughputLimit** are changed. See [Value changes by feature interdependencies](#) on page 151.

ExposureMode = Timed

For all Alvim cameras, exposure time can be set by `ExposureTime` or `ExposureAuto`. For this, `ExposureMode` is set to `Timed`.

The selected exposure time is extended automatically:

- If the selected exposure time does not match the available increment, the camera automatically extends the exposure time to the next increment.
- The **exposure time offset is included** in the selected exposure time.

ExposureMode = TriggerWidth or TriggerControlled

In addition, most global shutter (GS) cameras can control exposure time by the trigger signal, with the `ExposureMode` set to `TriggerWidth` or `TriggerControlLed` (using `ExposureStart` and `ExposureStop`).

The trigger controlled exposure time is extended automatically:

- If the trigger controlled exposure time does not match the available increment, the camera automatically extends the exposure time to the next increment.
- Subsequently, the **exposure time offset is added**.

You can use `ExposureActive` to determine the duration of the exposure time offset.

Operation for maximum frame rates

Values for maximum frame rates and for minimum and maximum exposure time in the specification tables are based on following parameters:

- Factory settings (camera after startup)
- Minimum exposure time
- Full resolution
- Mono8 pixel format or 8-Bit Bayer pixel format
- Camera operation in freerun mode
- Minimum value for `SensorBitDepth` (8-bit sensor ADC readout mode if available)
- Bandwidth required for the corresponding frame rate, as stated in the tables for ROI frame rates.

Bandwidth: Data is calculated for six steps in a range of 12 MBps and 122 MBps.

Bit depth: Values are calculated for Mono8. If you are using color formats or 10-bit or 12-bit pixel formats, frame rates fall below values for Mono8.

If `DeviceLinkThroughputLimit` is enabled, you can increase the `DeviceLinkThroughputLimit` value to increase maximum frame rates.

Triggering: If cameras are triggered, frame rates are lower.

Triggering and sensor shutter types

Triggering behavior differs between cameras with global shutter (GS) and electronic rolling shutter (ERS).

Triggering

The following table shows how the shutter mode impacts available frame rates:

Sensor type	Shutter mode	Trigger mode	Available frame rates	ROI frame rates
Global shutter	Global shutter	Freerun	Maximum values	Increased values
	Global shutter	External trigger	Maximum values	Increased values
Rolling shutter	Rolling shutter	Freerun	Maximum values	Increased values
	Rolling shutter	External trigger	Reduced values	Increased values
	Global reset shutter (GRS)	Freerun	Maximum values	No increase
	Global reset shutter (GRS)	External trigger	Maximum values	No increase

Table 12: Frame rates depending on shutter modes and trigger modes



Achieved frame rates may not match specified values

- Some sensors have an exposure start jitter that may reduce maximum frame rates.
- Your individual setup may cause delays in data transmission.



Bandwidth adjustments

Consider the bandwidth available for camera payload depends on your individual hardware, the operating system, software and drivers, and your application. We recommend you to adjust `DeviceLinkThroughputLimit` to your requirements.



Interdependencies between ROI and ExposureTime values

Changing parameters for ROI can affect values for `ExposureTime`, such as minimum, maximum, and increments, but `ExposureTime` itself as well. We recommend you to set:

- ROI values
- `DeviceLinkThroughputLimit`

before you set values for `ExposureTime`.

See [Value changes by feature interdependencies](#) on page 151 for details.

Digital binning

Alvium G1 cameras combine digital horizontal binning and digital vertical binning, for integer values 1 to 8.



Alvium G1 models \geq 12 MP resolution

If digital horizontal and digital vertical binning are set to 1 \times and the digital vertical binning value is increased, digital horizontal binning is automatically set to 2 \times .

Operation for typical power consumption



Accuracy of stated values

For some models, values have been calculated, including an offset to protect the camera and peripherals from damage. Values verified by measurements will be provided in a future version of this document.

Values for power consumption in the specification tables are based on following parameters:

- Factory settings (camera after startup)
- Minimum exposure time
- Maximum frame rate
- Full resolution
- Mono8 pixel format or 8-Bit Bayer pixel format
- Camera operation in freerun mode
- Sensor ADC readout using maximum bit depth
- Without bandwidth limitations.

Dimensions and mass

For your model's dimensions, see [Dimensions and mass](#) on page 92. For technical drawings, see [Technical drawings](#) on page 92.

Alvium G1 model specifications

Alvium G1-040m/c

Feature	Specification	
	G1-040m (monochrome)	G1-040c (color)
Sensor model	Sony IMX287	
Resolution	728 (H) × 544 (V); 0.4 MP	
Sensor type	CMOS	
Shutter type	Global shutter (GS)	
Sensor size	Type 1/2.9; 5 mm × 3.8 mm; 6.3 mm diagonal	
Pixel size	6.9 μm × 6.9 μm	
CRA	0 deg	
Sensor bit depth (ADC)	8-bit, 10-bit, 12-bit; Adaptive (10-bit, 12-bit)	
Monochrome pixel formats	Mono8 (default), Mono10, Mono10p, Mono12, Mono12p	Mono8, Mono10, Mono10p, Mono12, Mono12p
YUV color pixel formats	Not applicable	YCbCr411_8_CbYYCrYY, YCbCr422_8_CbYCrY, YCbCr8_CbYCr
RGB color pixel formats	Not applicable	BayerRG8, BayerRG10, BayerRG10p, BayerRG12, BayerRG12p, BGR8, RGB8 (default)
Maximum frame rate	276 fps	
Exposure time	27 μs to 10 s	
Exposure modes	Timed, TriggerControlled, TriggerWidth	
Gain	0 dB to 24 dB; 0.1 dB increments	
Digital binning	Horizontal: 1 to 8 columns; Vertical: 1 to 8 rows	
Image buffer (RAM)	32 MB	
Non-volatile memory (Flash)	1024 KB	
Inputs and outputs	1 opto-isolated input, 1 opto-isolated output, 2 non-isolated GPIOs ¹	
Power requirements	12 to 24 VDC	
Power requirements (PoE)	IEEE 802.3af	
Power consumption (typical)	External power: 3.1 W at 12 VDC Power over Ethernet: 3.4 W	
Storage temperature	-20 °C to +85 °C ambient temperature	
Operating temperature	-20 °C to +50 °C (Housing), +5 °C to +85 °C (Mainboard ²)	
Humidity	0% to 80% humidity (non-condensing)	
Digital interface	1000BASE-T	
Camera controls	GenICam V2.0 (GenICam Access)	

¹ Use with external power only, not with PoE. See [I/Os and power supply by PoE](#) on page 34.

² Output by DeviceTemperature

Table 13: Alvium G1-040m/c specifications

Absolute QE

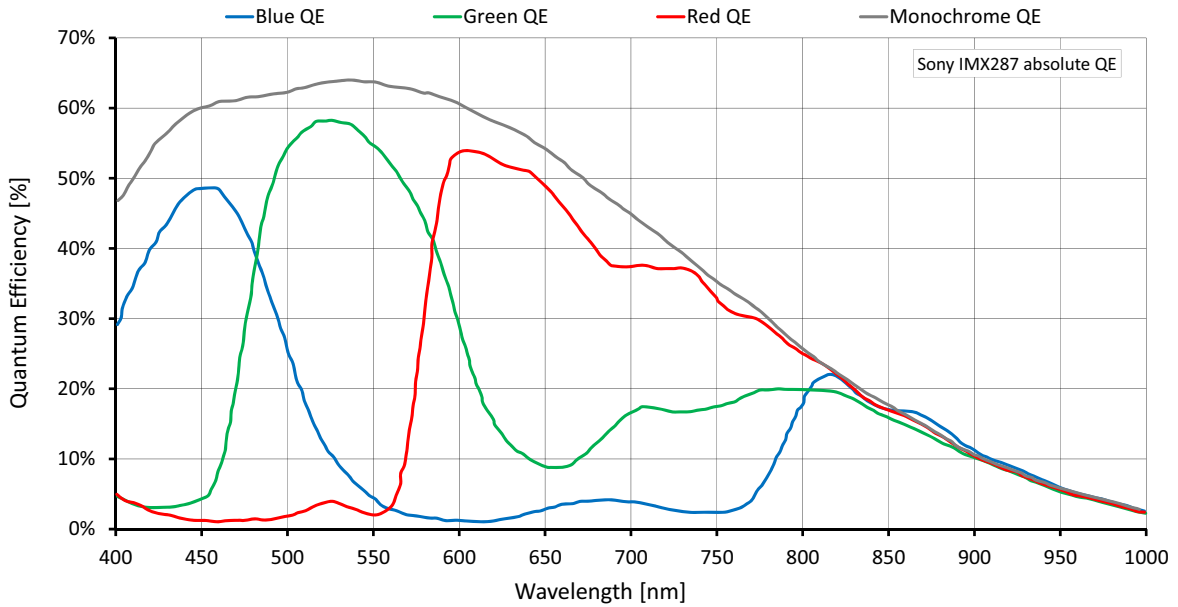

Figure 3: Alvium G1-040m/c (Sony IMX287) absolute QE

Spectral response

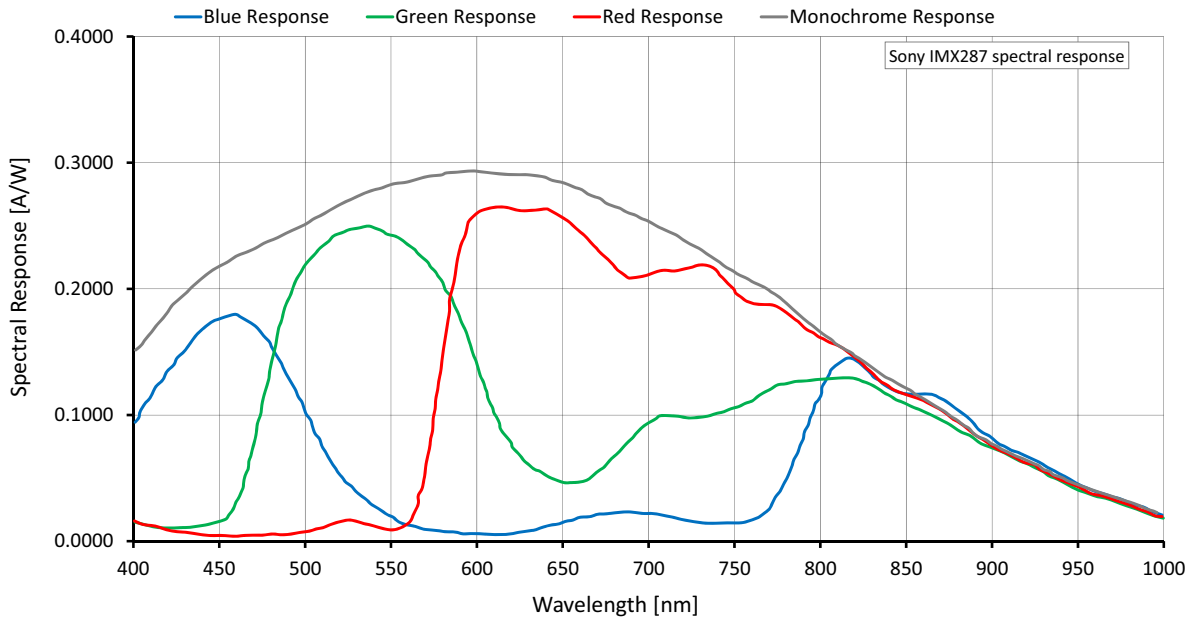

Figure 4: Alvium G1-040m/c (Sony IMX287) spectral response

ROI frame rates

Values are based on the conditions defined in [Operation for maximum frame rates](#) on page 43.

Image format	Width [pixels]	Height [pixels]	ROI area [MP]	Frame rate [fps] ¹	
				122 MBps	12 MBps
Full resolution	728	544	0.396	276.4 / 138.8 / 138.9	27.9 / 14.1 / 14.0
VGA	640	480	0.307	350.1 / 177.3 / 176.9	35.6 / 17.9 / 17.9
HVGA	480	320	0.154	616.7 / 336.7 / 333.2	63.2 / 34.1 / 34.0
QVGA	320	240	0.077	780.6 / 638.9 / 617.7	80.5 / 65.2 / 65.1
HQVGA	240	160	0.038	1063.2 / 1064.4 / 847.2	110.8 / 110.7 / 110.3
QQVGA	160	120	0.019	1298.2 / 1303.5 / 1037.7	136.6 / 136.4 / 136.0
Max. × half	728	272	0.198	502.2 / 253.6 / 253.4	51.4 / 25.9 / 25.8
Max. × min.	728	8	0.006	2423.6 / 1283.5 / 1266.9	277.5 / 139.6 / 139.3
Min. × max.	8	544	0.004	388.4 / 385.4 / 306.8	39.4 / 39.4 / 39.2
Min. × min.	8	8	64 P	3405.3 / 3515.6 / 2798.5	391.6 / 391.0 / 389.9

¹ Mono8 or Bayer...8⁽²⁾ at SensorBitDepth = 8-Bit⁽³⁾ /

Mono10 or Bayer...10 at SensorBitDepth = 10-Bit /

Mono12 or Bayer...12 at SensorBitDepth = 12-Bit

² The three dots... represent the colors of a Bayer pixel format, such as in BayerRG8.

³ The SensorBitDepth value must be set separately from PixelFormat.

See [Sensor ADC readout modes for maximum frame rates](#) on page 42 for details.

Table 14: Alvium G1-040m/c ROI frame rates

Alvium G1-158m/c

Feature	Specification	
	G1-158m (monochrome)	G1-158c (color)
Sensor model	Sony IMX273	
Resolution	1456 (H) × 1088 (V); 1.6 MP	
Sensor type	CMOS	
Shutter type	Global shutter (GS)	
Sensor size	Type 1/2.9; 5 mm × 3.8 mm; 6.3 mm diagonal	
Pixel size	3.45 μm × 3.45 μm	
CRA	0 deg	
Sensor bit depth (ADC)	8-bit, 10-bit, 12-bit; Adaptive (10-bit, 12-bit)	
Monochrome pixel formats	Mono8 (default), Mono10, Mono10p, Mono12, Mono12p	Mono8, Mono10, Mono10p, Mono12, Mono12p
YUV color pixel formats	Not applicable	YCbCr411_8_CbYYCrYY, YCbCr422_8_CbYCrY, YCbCr8_CbYCr
RGB color pixel formats	Not applicable	BayerRG8, BayerRG10, BayerRG10p, BayerRG12, BayerRG12p, BGR8, RGB8 (default)
Maximum frame rate	72 fps	
Exposure time	39 μs to 10 s	
Exposure modes	Timed, TriggerControlled, TriggerWidth	
Gain	0 dB to 24 dB; 0.1 dB increments	
Digital binning	Horizontal: 1 to 8 columns; Vertical: 1 to 8 rows	
Image buffer (RAM)	32 MB	
Non-volatile memory (Flash)	1024 KB	
Inputs and outputs	1 opto-isolated input, 1 opto-isolated output, 2 non-isolated GPIOs ¹	
Power requirements	12 to 24 VDC	
Power requirements (PoE)	IEEE 802.3af	
Power consumption (typical)	External power: 3.6 W at 12 VDC Power over Ethernet: 3.9 W	
Storage temperature	-20 °C to +85 °C ambient temperature	
Operating temperature	-20 °C to +50 °C (Housing), +5 °C to +85 °C (Mainboard ²)	
Humidity	0% to 80% humidity (non-condensing)	
Digital interface	1000BASE-T	
Camera controls	GenICam V2.0 (GenICam Access)	

¹ Use with external power only, not with PoE. See [I/Os and power supply by PoE](#) on page 34.

² Output by `DeviceTemperature`

Table 15: Alvium G1-158m/c specifications

Absolute QE

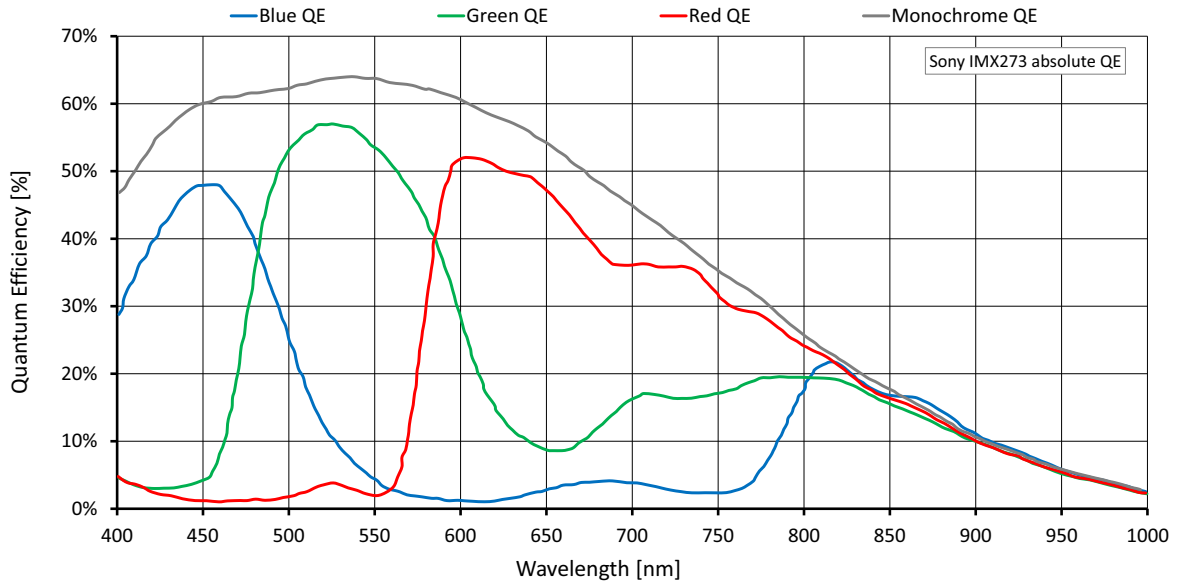

Figure 5: Alvium G1-158m/c (Sony IMX273) absolute QE

Spectral response

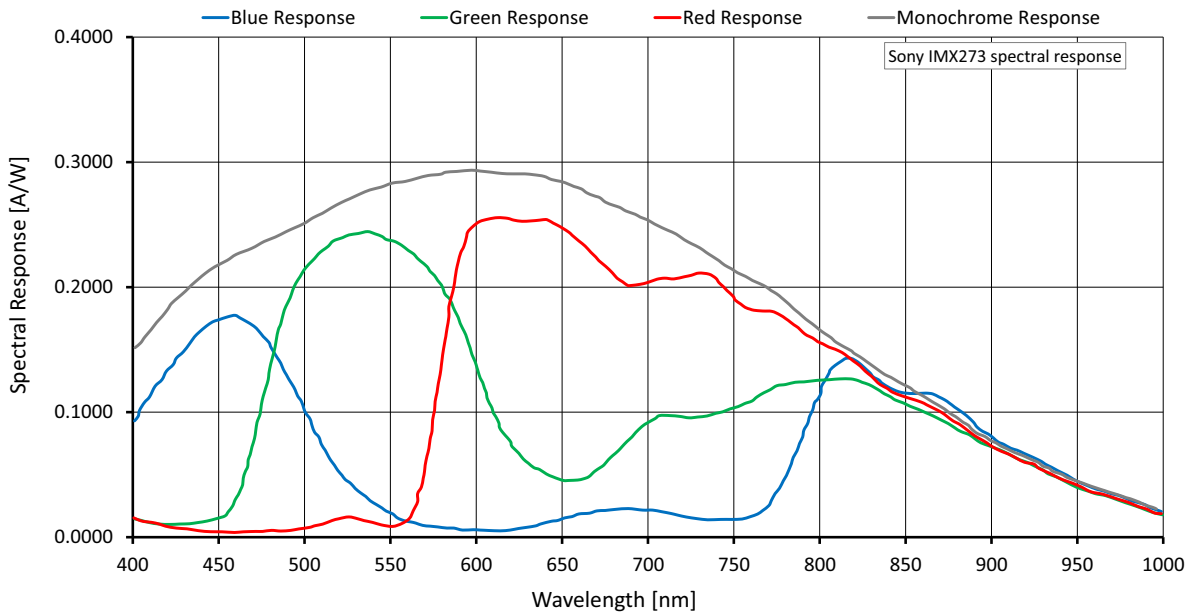

Figure 6: Alvium G1-158m/c (Sony IMX273) spectral response

ROI frame rates

Values are based on the conditions defined in [Operation for maximum frame rates](#) on page 43.

Image format	Width [pixels]	Height [pixels]	ROI area [MP]	Frame rate [fps] ¹	
				122 MBps	12 MBps
Full resolution	1456	1088	1.584	72.7 / 36.5 / 36.5	7.3 / 3.6 / 3.6
WXGA+	1440	900	1.296	87.7 / 44.2 / 44.0	8.8 / 4.4 / 4.4
SXGA	1280	1024	1.311	87.7 / 44.0 / 44.0	8.7 / 4.4 / 4.4
HD 720	1280	720	0.922	121.7 / 61.2 / 61.1	12.2 / 6.1 / 6.1
XGA	1024	768	0.786	143.4 / 71.9 / 71.9	14.4 / 7.2 / 7.2
SVGA	800	600	0.480	229.8 / 115.7 / 115.2	23.2 / 11.7 / 11.7
VGA	640	480	0.307	349.5 / 176.9 / 176.6	35.5 / 17.9 / 17.9
HVGA	480	320	0.154	615.1 / 335.8 / 333.2	63.0 / 34.1 / 34.0
QVGA	320	240	0.077	778.0 / 638.9 / 617.7	80.2 / 65.2 / 65.1
HQVGA	240	160	0.038	1058.4 / 1064.4 / 847.2	110.3 / 110.7 / 110.3
QQVGA	160	120	0.019	1291.0 / 1303.5 / 1037.7	135.8 / 136.4 / 136.0
Max. x half	1456	544	0.792	138.0 / 69.5 / 69.3	13.9 / 7.0 / 7.0
Max. x min.	1456	8	0.012	1194.5 / 633.8 / 624.0	136.5 / 69.8 / 69.6
Min. x max.	8	1088	0.009	204.3 / 202.5 / 161.2	20.6 / 20.6 / 20.5
Min. x min.	8	8	64 P	3356.7 / 3515.6 / 2798.5	385.2 / 391.0 / 389.9

¹ Mono8 or Bayer...8⁽²⁾ at SensorBitDepth = 8-Bit⁽³⁾ /
 Mono10 or Bayer...10 at SensorBitDepth = 10-Bit /
 Mono12 or Bayer...12 at SensorBitDepth = 12-Bit

² The three dots... represent the colors of a Bayer pixel format, such as in BayerRG8.

³ The SensorBitDepth value must be set separately from PixelFormat.

See [Sensor ADC readout modes for maximum frame rates](#) on page 42 for details.

Table 16: Alvium G1-158m/c ROI frame rates

Alvium G1-234m/c (coming soon)

Feature	Specification	
	G1-234m	G1-234c
Sensor model	Sony IMX249	
Resolution	1936 (H) × 1216 (V); 2.35 MP	
Sensor type	CMOS	
Shutter type	Global shutter (GS)	
Sensor size	Type 1/1.2; 11.3 mm × 7.1 mm; 13.4 mm diagonal	
Pixel size	5.86 μm × 5.86 μm	
CRA	0 deg	
Sensor bit depth (ADC)	10-bit, 12-bit; Adaptive (10-bit, 12-bit)	
Monochrome pixel formats	Mono8 (default), Mono10, Mono10p	Mono8, Mono10, Mono10p
YUV color pixel formats	Not applicable	YCbCr411_8_CbYYCrYY, YCbCr422_8_CbYCrY, YCbCr8_CbYCr
RGB color pixel formats	Not applicable	BayerGR8, BayerGR10, BayerGR10p, BGR8, RGB8 (default)
Maximum frame rate	40 fps	
Exposure time	53 μs to 10 s	
Exposure modes	Timed	
Gain	0 dB to 24 dB; 0.1 dB increments	
Digital binning	Horizontal: 1 to 8 columns; Vertical: 1 to 8 rows	
Image buffer (RAM)	32 MB	
Non-volatile memory (Flash)	1024 KB	
Inputs and outputs	1 opto-isolated input, 1 opto-isolated output, 2 non-isolated GPIOs ¹	
Power requirements	12 to 24 VDC	
Power requirements (PoE)	IEEE 802.3af	
Power consumption (typical)	External power: 3.0 W at 12 VDC Power over Ethernet: 3.3 W	
Storage temperature	-20 °C to +85 °C ambient temperature	
Operating temperature	-20 °C to +55 °C (Housing), +5 °C to +85 °C (Mainboard ²)	
Humidity	0% to 80% humidity (non-condensing)	
Digital interface	1000BASE-T	
Camera controls	GenICam V2.0 (GenICam Access)	

¹ Use with external power only, not with PoE. See [I/Os and power supply by PoE](#) on page 34.

² Output by `DeviceTemperature`

Table 17: Alvium G1-234m/c specifications

Absolute QE

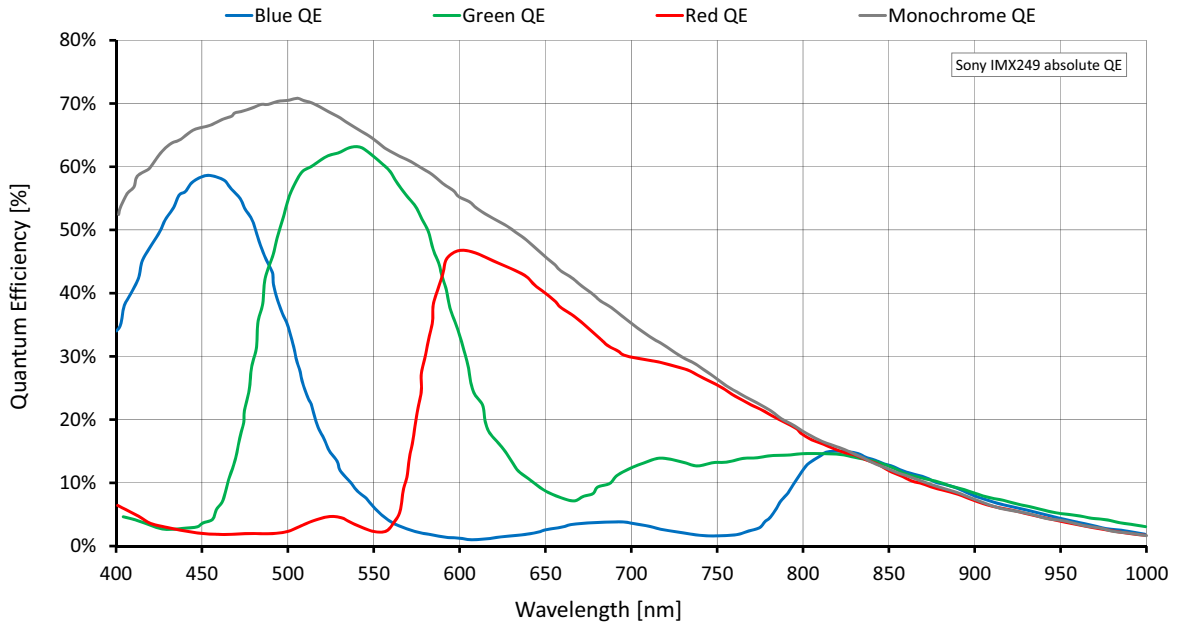

Figure 7: Alvim G1-234m/c (Sony IMX249) absolute QE

Spectral response

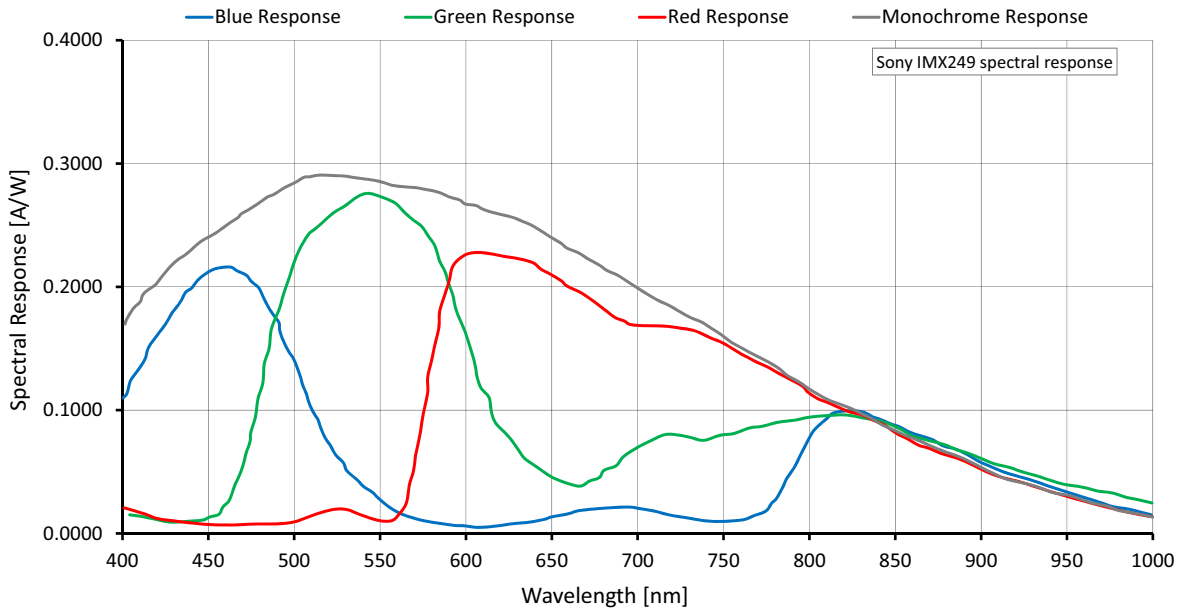

Figure 8: Alvim G1-234m/c (Sony IMX249) spectral response

ROI frame rates

Values are based on the conditions defined in [Operation for maximum frame rates](#) on page 43.

Image format	Width [pixels]	Height [pixels]	ROI area [MP]	Frame rate [fps] ¹	
				122 MBps	12 MBps
Full resolution	1936	1216	2,354	40.5 / 24.8	4.9 / 2.4
Full HD	1920	1080	2,074	45.3 / 28.0	5.6 / 2.8
UXGA	1600	1200	1,920	41.0 / 30.4	6.1 / 3.0
WXGA+	1440	900	1,296	54.0 / 42.1	8.9 / 4.4
SXGA	1280	1024	1,311	47.8 / 37.2	8.8 / 4.4
HD 720	1280	720	0.922	66.6 / 51.9	12.4 / 6.1
XGA	1024	768	0.786	62.7 / 48.9	14.6 / 7.2
SVGA	800	600	0.480	79.0 / 61.6	23.5 / 11.7
VGA	640	480	0.307	97.0 / 75.6	36.1 / 18.0
HVGA	480	320	0.154	139.2 / 108.5	69.0 / 34.4
QVGA	320	240	0.077	177.8 / 138.6	132.2 / 66.0
HQVGA	240	160	0.038	245.9 / 192.5	242.5 / 121.7
QQVGA	160	120	0.019	305.9 / 238.4	305.9 / 225.9
Max. × half	1936	608	1,177	77.6 / 47.7	9.6 / 4.7
Max. × min.	1936	8	0.015	828.8 / 524.8	112.5 / 56.1
Min. × max.	8	1216	0.010	40.6 / 31.7	
Min. × min.	8	8	64 P	917.6 / 715.1	

¹ Mono8 or Bayer...8⁽²⁾ at SensorBitDepth = 10-Bit / Mono12 or Bayer...12 at SensorBitDepth = 12-Bit

² The three dots... represent the colors of a Bayer pixel format, such as in BayerRG8.

Table 18: Alvium G1-234m/c ROI frame rates

Alvium G1-240m/c

Feature	Specification	
	G1-240m (monochrome)	G1-240c (color)
Sensor model	Sony IMX392	
Resolution	1936 (H) × 1216 (V); 2.4 MP	
Sensor type	CMOS	
Shutter type	Global shutter (GS)	
Sensor size	Type 1/2.3; 6.7 mm × 4.2 mm; 7.9 mm diagonal	
Pixel size	3.45 μm × 3.45 μm	
CRA	0 deg	
Sensor bit depth (ADC)	8-bit, 10-bit, 12-bit; Adaptive (10-bit, 12-bit)	
Monochrome pixel formats	Mono8 (default), Mono10, Mono10p, Mono12, Mono12p	Mono8, Mono10, Mono10p, Mono12, Mono12p
YUV color pixel formats	Not applicable	YCbCr411_8_CbYYCrYY, YCbCr422_8_CbYCrY, YCbCr8_CbYCr
RGB color pixel formats	Not applicable	BayerRG8, BayerRG10, BayerRG10p, BayerRG12, BayerRG12p, BGR8, RGB8 (default)
Maximum frame rate	49 fps	
Exposure time	46 μs to 10 s	
Exposure modes	Timed, TriggerControlled, TriggerWidth	
Gain	0 dB to 24 dB; 0.1 dB increments	
Digital binning	Horizontal: 1 to 8 columns; Vertical: 1 to 8 rows	
Image buffer (RAM)	32 MB	
Non-volatile memory (Flash)	1024 KB	
Inputs and outputs	1 opto-isolated input, 1 opto-isolated output, 2 non-isolated GPIOs ¹	
Power requirements	12 to 24 VDC	
Power requirements (PoE)	IEEE 802.3af	
Power consumption (typical)	External power: 3.6 W at 12 VDC Power over Ethernet: 4.0 W	
Storage temperature	-20 °C to +85 °C ambient temperature	
Operating temperature	-20 °C to +50 °C (Housing), +5 °C to +85 °C (Mainboard ²)	
Humidity	0% to 80% humidity (non-condensing)	
Digital interface	1000BASE-T	
Camera controls	GenICam V2.0 (GenICam Access)	

¹ Use with external power only, not with PoE. See [I/Os and power supply by PoE](#) on page 34.

² Output by DeviceTemperature

Table 19: Alvium G1-240m/c specifications

Absolute QE

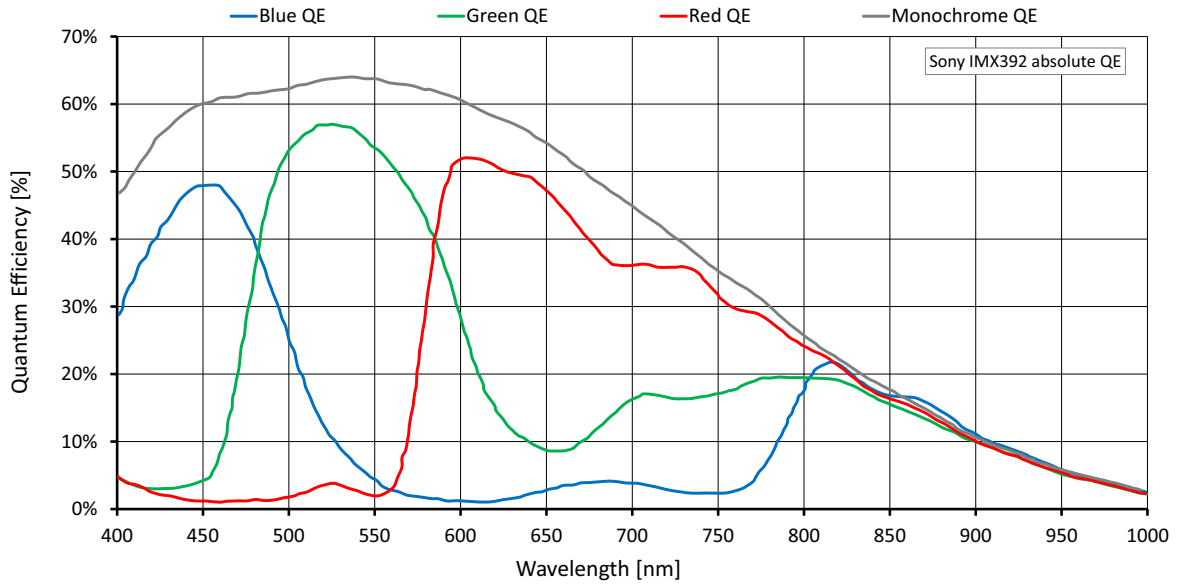

Figure 9: Alvium G1-240m/c (Sony IMX392) absolute QE

Spectral response

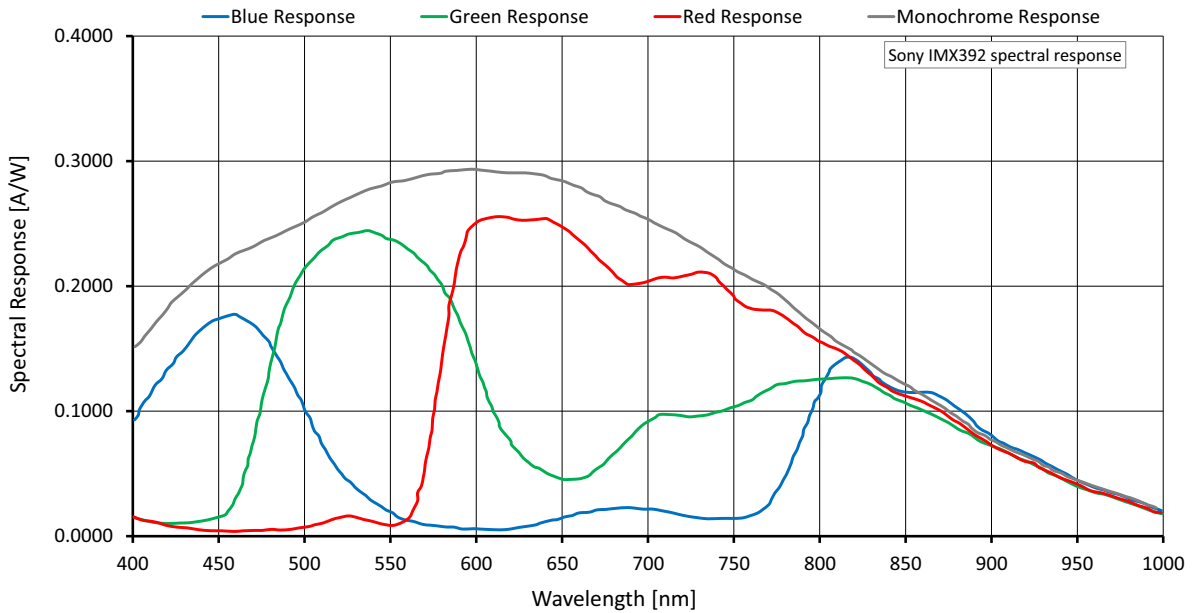

Figure 10: Alvium G1-240m/c (Sony IMX392) spectral response

ROI frame rates

Values are based on the conditions defined in [Operation for maximum frame rates](#) on page 43.

Image format	Width [pixels]	Height [pixels]	ROI area [MP]	Frame rate [fps] ¹	
				122 MBps	12 MBps
Full resolution	1936	1216	2.354	49.4 / 24.8 / 24.9	4.9 / - / 2.4
Full HD	1920	1080	2.074	55.7 / 28.0 / 28.1	5.5 / - / 2.8
UXGA	1600	1200	1.920	60.5 / 30.4 / 30.4	6.0 / - / 3.0
WXGA+	1440	900	1.296	88.1 / 44.4 / 44.4	8.8 / - / 4.4
SXGA	1280	1024	1.311	88.0 / 44.2 / 44.3	8.8 / - / 4.4
HD 720	1280	720	0.922	122.4 / 61.6 / 61.7	12.3 / - / 6.2
XGA	1024	768	0.786	144.1 / 72.4 / 72.6	14.4 / - / 7.3
SVGA	800	600	0.480	231.2 / 116.8 / 116.6	23.3 / - / 11.8
VGA	640	480	0.307	352.1 / 178.9 / 179.3	35.8 / - / 18.1
HVGA	480	320	0.154	621.6 / 341.2 / 340.4	63.6 / - / 34.8
QVGA	320	240	0.077	788.5 / 652.0 / 574.7	81.3 / - / 66.9
HQVGA	240	160	0.038	1077.8 / 972.9 / 800.1	112.4 / - / 114.6
QQVGA	160	120	0.019	1320.0 / 1199.1 / 989.5	139.0 / - / 142.6
Max. × half	1936	608	1.177	94.5 / 47.7 / 47.8	9.5 / - / 4.8
Max. × min.	1936	8	0.015	953.4 / 524.4 / 533.7	109.8 / - / 60.4
Min. × max.	8	1216	0.010	184.4 / 162.7 / 132.2	18.5 / - / 18.5
Min. × min.	8	8	64 P	3560.1 / 3437.5 / 2933.9	412.2 / - / 449.8

¹Mono8 or Bayer...8⁽²⁾ at **SensorBitDepth** = 8-Bit⁽³⁾ /
 Mono10 or Bayer...10 at **SensorBitDepth** = 10-Bit /
 Mono12 or Bayer...12 at **SensorBitDepth** = 12-Bit

²The three dots... represent the colors of a Bayer pixel format, such as in Bayer**RG8**.

³The **SensorBitDepth** value must be set separately from **PixelFormat**.

See [Sensor ADC readout modes for maximum frame rates](#) on page 42 for details.

Table 20: Alvium G1-240m/c ROI frame rates

Alvium G1-319m/c

Feature	Specification	
	G1-319m (monochrome)	G1-319c (color)
Sensor model	Sony IMX265	
Resolution	2064 (H) × 1544 (V); 3.2 MP	
Sensor type	CMOS	
Shutter type	Global shutter (GS)	
Sensor size	Type 1/1.8; 7.1 mm × 5.3 mm; 8.9 mm diagonal	
Pixel size	3.45 μm × 3.45 μm	
CRA	0 deg	
Sensor bit depth (ADC)	12-bit	
Monochrome pixel formats	Mono8 (default), Mono10, Mono10p, Mono12, Mono12p	Mono8, Mono10, Mono10p, Mono12, Mono12p
YUV color pixel formats	Not applicable	YCbCr411_8_CbYYCrYY, YCbCr422_8_CbYCrY, YCbCr8_CbYCr
RGB color pixel formats	Not applicable	BayerRG8, BayerRG10, BayerRG10p, BayerRG12, BayerRG12p, BGR8, RGB8 (default)
Maximum frame rate	36 fps	
Exposure time	49 μs to 10 s	
Exposure modes	Timed, TriggerControlled, TriggerWidth	
Gain	0 dB to 24 dB; 0.1 dB increments	
Digital binning	Horizontal: 1 to 8 columns; Vertical: 1 to 8 rows	
Image buffer (RAM)	32 MB	
Non-volatile memory (Flash)	1024 KB	
Inputs and outputs	1 opto-isolated input, 1 opto-isolated output, 2 non-isolated GPIOs ¹	
Power requirements	12 to 24 VDC	
Power requirements (PoE)	IEEE 802.3af	
Power consumption (typical)	External power: 3.0 W at 12 VDC Power over Ethernet: 3.3 W	
Storage temperature	-20 °C to +85 °C ambient temperature	
Operating temperature	-20 °C to +55 °C (Housing), +5 °C to +85 °C (Mainboard ²)	
Humidity	0% to 80% humidity (non-condensing)	
Digital interface	1000BASE-T	
Camera controls	GenICam V2.0 (GenICam Access)	

¹ Use with external power only, not with PoE. See [I/Os and power supply by PoE](#) on page 34.

² Output by DeviceTemperature

Table 21: Alvium G1-319m/c specifications

Absolute QE

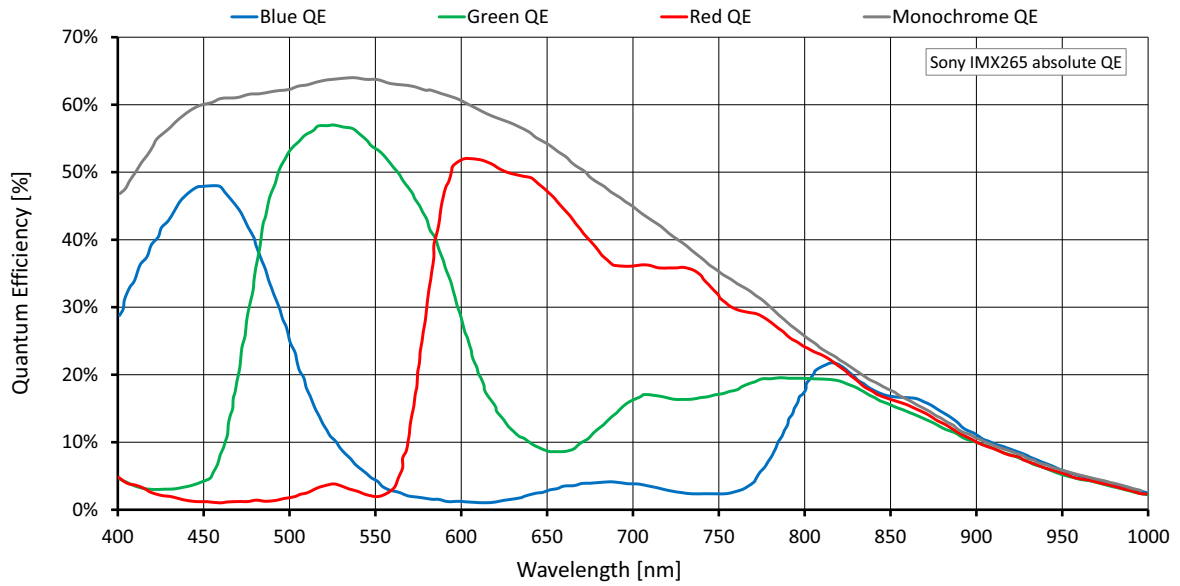

Figure 11: Alvium G1-319m/c (Sony IMX265) absolute QE

Spectral response

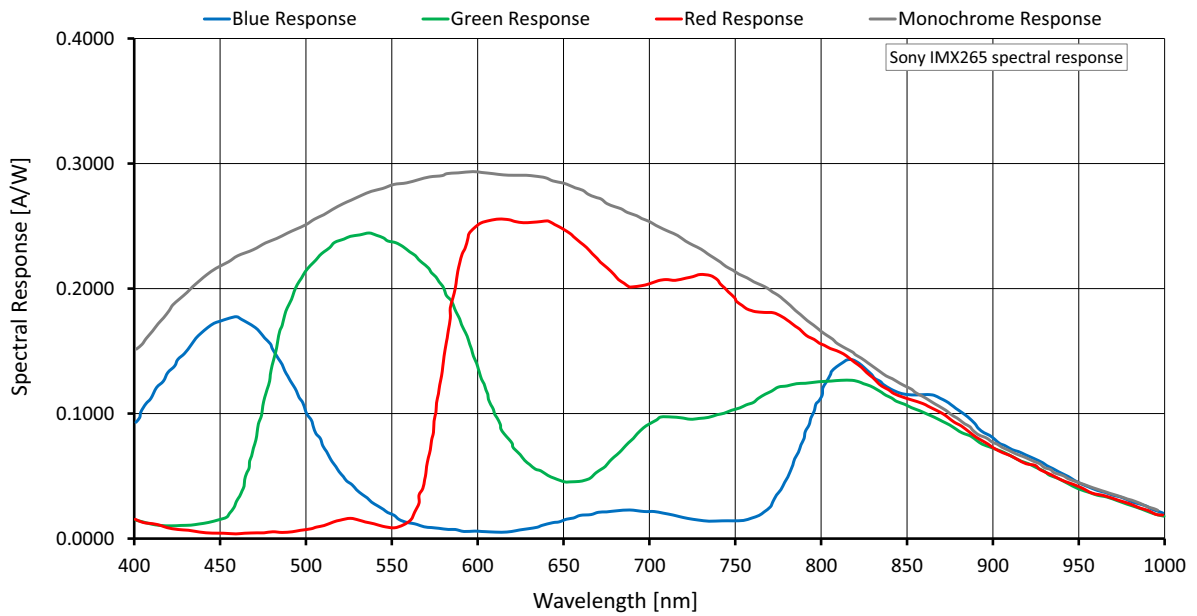

Figure 12: Alvium G1-319m/c (Sony IMX265) spectral response

ROI frame rates

Values are based on the conditions defined in [Operation for maximum frame rates](#) on page 43.

Image format	Width [pixels]	Height [pixels]	ROI area [MP]	Frame rate [fps] ¹	
				122 MBps	12 MBps
Full resolution	2064	1544	3.187	36.8 / 18.5	3.7 / 1.8
QXGA	2048	1536	3.146	37.3 / 18.7	3.7 / 1.8
Full HD	1920	1080	2.074	55.7 / 28.0	5.6 / 2.8
UXGA	1600	1200	1.920	60.3 / 30.4	6.1 / 3.0
WXGA+	1440	900	1.296	87.8 / 44.4	8.9 / 4.4
SXGA	1280	1024	1.311	80.5 / 44.2	8.8 / 4.4
HD 720	1280	720	0.922	112.0 / 61.6	12.3 / 6.2
XGA	1024	768	0.786	105.9 / 72.6	14.5 / 7.2
SVGA	800	600	0.480	133.5 / 116.4	23.5 / 11.7
VGA	640	480	0.307	163.8 / 163.8	36.0 / 18.0
HVGA	480	320	0.154	235.5 / 235.5	68.9 / 34.6
QVGA	320	240	0.077	301.6 / 301.6	132.2 / 66.4
HQVGA	240	160	0.038	419.0 / 419.0	225.5 / 113.5
QQVGA	160	120	0.019	518.7 / 518.7	279.6 / 140.9
Max. × half	2064	772	1.593	70.9 / 35.8	7.2 / 3.6
Max. × min.	2064	8	0.017	879.5 / 492.2	107.1 / 54.5
Min. × max.	8	1544	0.012	54.7 / 54.7	29.3 / 14.7
Min. × min.	8	8	64 P	1556.2 / 1556.2	849.0 / 433.2

¹ Mono8 or Bayer...8⁽²⁾ at SensorBitDepth = 12-Bit / Mono12 or Bayer...12 at SensorBitDepth = 12-Bit

² The three dots... represent the colors of a Bayer pixel format, such as in BayerRG8.

Table 22: Alvium G1-319m/c ROI frame rates

Alvium G1-500m/c

Feature	Specification	
	G1-500m	G1-500c
Sensor model	ON Semiconductor AR0521SR	
Resolution	2592 (H) × 1944 (V); 5.0 MP	
Sensor type	CMOS	
Shutter type	Rolling shutter (RS)	
Sensor size	Type 1/2.5; 5.7 mm × 4.3 mm; 7.1 mm diagonal	
Pixel size	2.2 μm × 2.2 μm	
CRA	9 deg	
Sensor bit depth (ADC)	10-bit	
Monochrome pixel formats	Mono8 (default), Mono10, Mono10p	Mono8, Mono10, Mono10p
YUV color pixel formats	Not applicable	YCbCr411_8_CbYYCrYY, YCbCr422_8_CbYCrY, YCbCr8_CbYCr
RGB color pixel formats	Not applicable	BayerGR8, BayerGR10, BayerGR10p, BGR8, RGB8 (default)
Maximum frame rate	23 fps	
Exposure time	22 μs to 1.4 s	
Exposure modes	Timed	
Gain	0 dB to 24.1 dB; 0.1 dB increments	
Digital binning	Horizontal: 1 to 8 columns; Vertical: 1 to 8 rows	
Image buffer (RAM)	32 MB	
Non-volatile memory (Flash)	1024 KB	
Inputs and outputs	1 opto-isolated input, 1 opto-isolated output, 2 non-isolated GPIOs ²	
Power requirements	12 to 24 VDC	
Power requirements (PoE)	IEEE 802.3af	
Power consumption (typical)	External power: 2.9 W at 12 VDC Power over Ethernet: 3.2 W	
Storage temperature	-20 °C to +85 °C ambient temperature	
Operating temperature	-20 °C to +55 °C (Housing), +5 °C to +85 °C (Mainboard ³)	
Humidity	0% to 80% humidity (non-condensing)	
Digital interface	1000BASE-T	
Camera controls	GenICam V2.0 (GenICam Access)	
¹ In triggered mode: 11 fps ² Use with external power only, not with PoE. See I/Os and power supply by PoE on page 34. ³ Output by <code>DeviceTemperature</code>		

Table 23: Alvium G1-500m/c specifications

Absolute QE

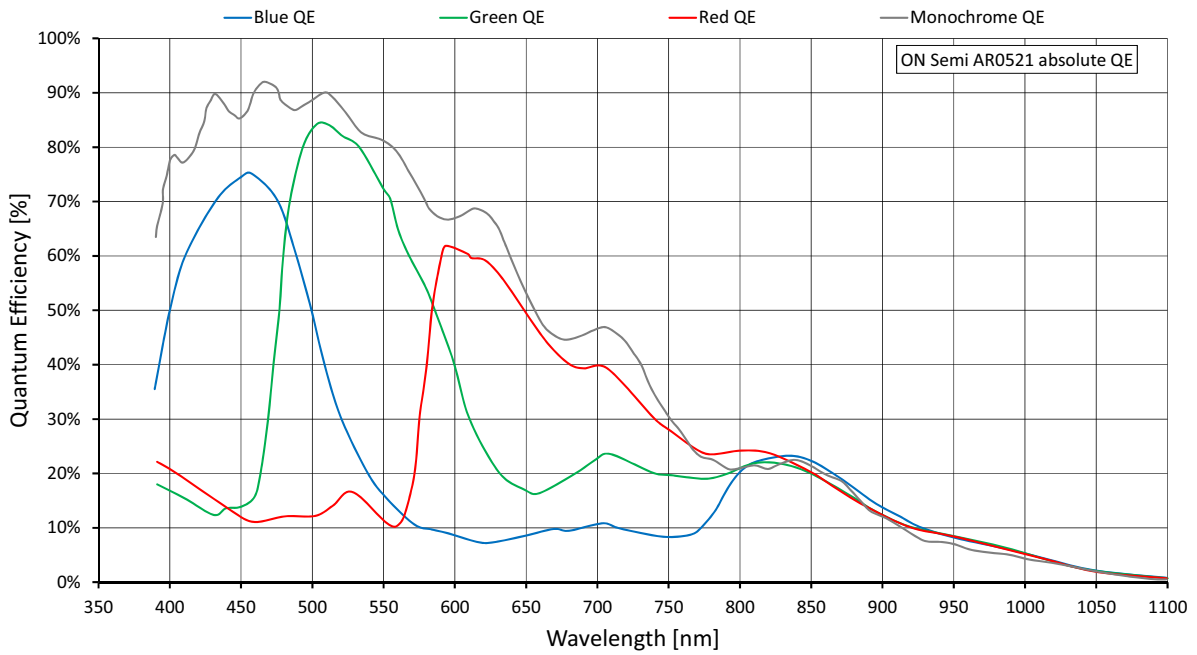

Figure 13: Alvium G1-500m/c (ON Semi AR0521) absolute QE

Spectral response

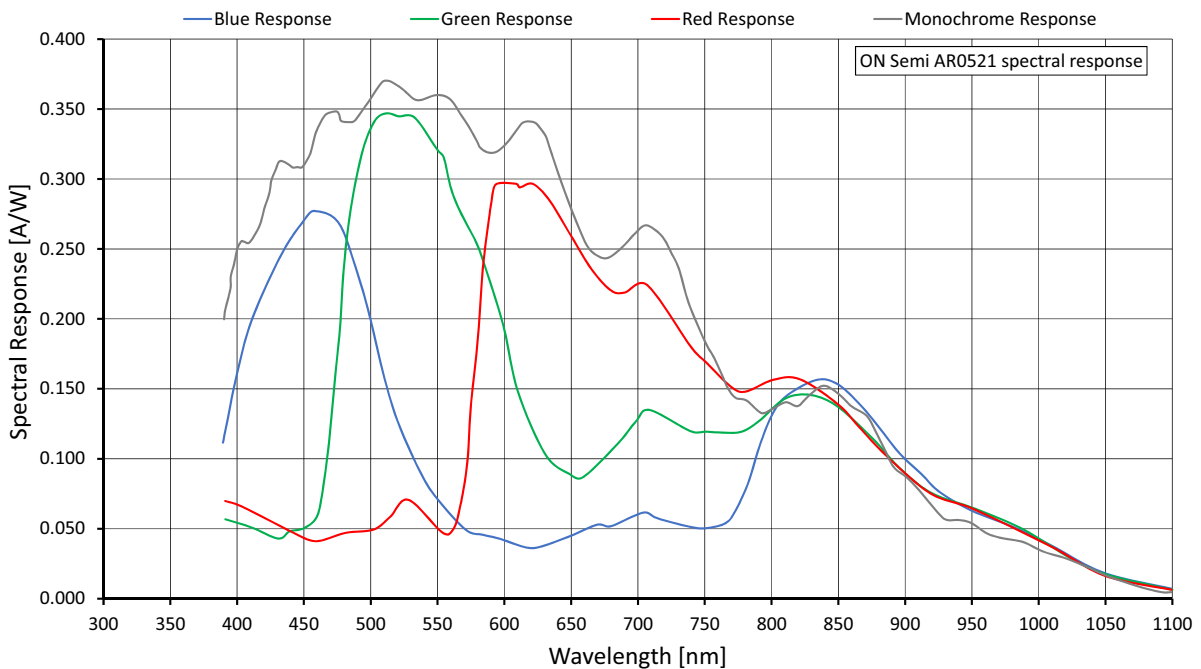

Figure 14: Alvium G1-500m/c (ON Semi AR0521) spectral response

ROI frame rates

Values are based on the conditions defined in [Operation for maximum frame rates](#) on page 43.

When rolling shutter cameras are **operated in triggered mode**, the values for maximum frame rate reached in free run mode are cut in half.

Currently, Alvium G1-500 models cannot be operated at 12 MBps.

Image format	Width [pixels]	Height [pixels]	ROI area [MP]	Frame rate [fps] ¹
				122 MBps
Full resolution	2592	1944	5.039	23.7 / 11.9
WQHD	2560	1440	3.686	32.1 / 16.1
QXGA	2048	1536	3.146	37.7 / 18.9
Full HD	1920	1080	2.074	56.6 / 28.4
UXGA	1600	1200	1.920	61.4 / 30.7
WXGA+	1440	900	1.296	89.8 / 45.1
SXGA	1280	1024	1.311	89.3 / 44.8
HD 720	1280	720	0.922	124.9 / 62.7
XGA	1024	768	0.786	146.8 / 73.7
SVGA	800	600	0.480	212.1 / 119.2
VGA	640	480	0.307	261.4 / 183.3
HVGA	480	320	0.154	378.3 / 353.2
QVGA	320	240	0.077	488.1 / 488.1
HQVGA	240	160	0.038	684.2 / 684.2
QQVGA	160	120	0.019	856.3 / 856.3
Max. × half	2592	972	2.519	46.4 / 23.2
Max. × min.	2592	8	0.021	922.7 / 490.2
Min. × max.	8	1944	0.016	68.7 / 68.7
Min. × min.	8	8	64 P	2895.6 / 2895.6

¹ Mono8 or Bayer...8⁽²⁾ at **SensorBitDepth** = 10-Bit / Mono10 or Bayer...10 at **SensorBitDepth** = 10-Bit

² The three dots... represent the colors of a Bayer pixel format, such as in Bayer**RG8**.

Table 24: Alvium G1-500m/c ROI frame rates

Alvium G1-507m/c

Feature	Specification	
	G1-507m (monochrome)	G1-507c (color)
Sensor model	Sony IMX264	
Resolution	2464 (H) × 2056 (V); 5.1 MP	
Sensor type	CMOS	
Shutter type	Global shutter (GS)	
Sensor size	Type 2/3; 8.5 mm × 7.1 mm; 11.1 mm diagonal	
Pixel size	3.45 μm × 3.45 μm	
CRA	0 deg	
Sensor bit depth (ADC)	12-bit	
Monochrome pixel formats	Mono8 (default), Mono10, Mono10p, Mono12, Mono12p	Mono8, Mono10, Mono10p, Mono12, Mono12p
YUV color pixel formats	Not applicable	YCbCr411_8_CbYYCrYY, YCbCr422_8_CbYCrY, YCbCr8_CbYCr
RGB color pixel formats	Not applicable	BayerRG8, BayerRG10, BayerRG10p, BayerRG12, BayerRG12p, BGR8, RGB8 (default)
Maximum frame rate	23 fps	
Exposure time	55 μs to 10 s	
Exposure modes	Timed, TriggerControlled, TriggerWidth	
Gain	0 dB to 24 dB; 0.1 dB increments	
Digital binning	Horizontal: 1 to 8 columns; Vertical: 1 to 8 rows	
Image buffer (RAM)	32 MB	
Non-volatile memory (Flash)	1024 KB	
Inputs and outputs	1 opto-isolated input, 1 opto-isolated output, 2 non-isolated GPIOs ¹	
Power requirements	12 to 24 VDC	
Power requirements (PoE)	IEEE 802.3af	
Power consumption (typical)	External power: 3.1 W at 12 VDC Power over Ethernet: 3.4 W	
Storage temperature	-20 °C to +85 °C ambient temperature	
Operating temperature	-20 °C to +55 °C (Housing), +5 °C to +85 °C (Mainboard ²)	
Humidity	0% to 80% humidity (non-condensing)	
Digital interface	1000BASE-T	
Camera controls	GenICam V2.0 (GenICam Access)	

¹ Use with external power only, not with PoE. See [I/Os and power supply by PoE](#) on page 34.

² Output by DeviceTemperature

Table 25: Alvium G1-507m/c specifications

Absolute QE

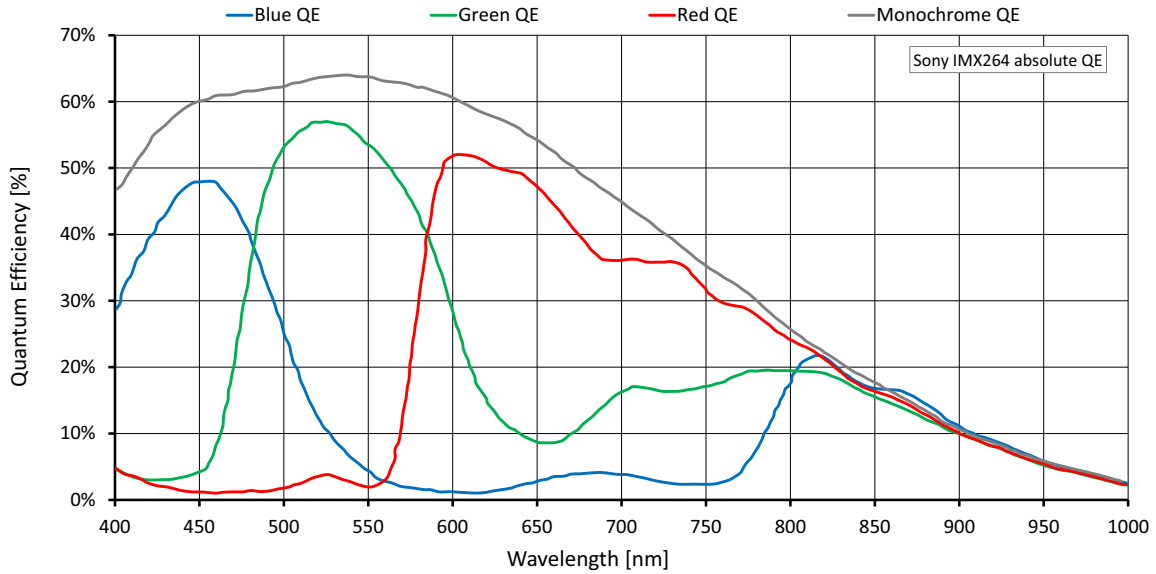

Figure 15: Alvium G1-507m/c (Sony IMX264) absolute QE

Spectral response

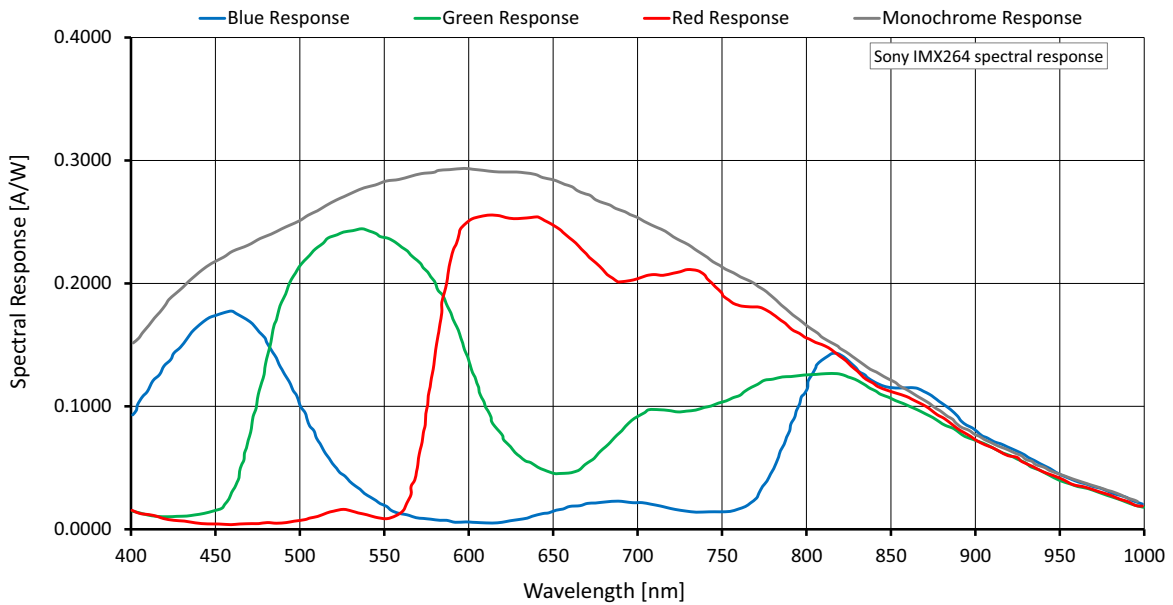

Figure 16: Alvium G1-507m/c (Sony IMX264) spectral response

ROI frame rates

Values are based on the conditions defined in [Operation for maximum frame rates](#) on page 43.

Image format	Width [pixels]	Height [pixels]	ROI area [MP]	Frame rate [fps] ¹	
				122 MBps	12 MBps
Full resolution	2464	2056	5.066	23.4 / 11.7	2.3 / 1.1
QXGA	2048	1536	3.146	37.3 / 18.7	3.7 / 1.8
Full HD	1920	1080	2.074	55.7 / 28.0	5.6 / 2.8
UXGA	1600	1200	1.920	58.9 / 30.4	6.1 / 3.0
WXGA+	1440	900	1.296	77.4 / 44.4	8.9 / 4.4
SXGA	1280	1024	1.311	68.6 / 44.2	8.8 / 4.4
HD 720	1280	720	0.922	95.5 / 61.6	12.3 / 6.2
XGA	1024	768	0.786	90.2 / 72.6	14.5 / 7.2
SVGA	800	600	0.480	113.7 / 113.7	23.5 / 11.7
VGA	640	480	0.307	139.6 / 139.6	36.0 / 18.0
HVGA	480	320	0.154	200.3 / 200.3	68.9 / 34.6
QVGA	320	240	0.077	257.3 / 257.3	132.2 / 66.4
HQVGA	240	160	0.038	356.3 / 356.3	225.5 / 113.5
QQVGA	160	120	0.019	441.1 / 441.1	279.6 / 140.9
Max. × half	2464	1028	2.533	45.5 / 22.9	4.5 / 2.3
Max. × min.	2464	8	0.020	738.8 / 412.5	89.7 / 45.7
Min. × max.	8	2056	0.016	35.2 / 35.2	22.2 / 11.1
Min. × min.	8	8	64 P	1323.2 / 1323.2	849.0 / 433.2

¹ Mono8 or Bayer...8⁽²⁾ at SensorBitDepth = 12-Bit/
 Mono12 or Bayer...12 at SensorBitDepth = 12-Bit

² The three dots... represent the colors of a Bayer pixel format, such as in Bayer**RG8**.

Table 26: Alvium G1-507m/c ROI frame rates

Alvium G1-510m/c (coming soon)

Feature	Specification	
	G1-510m (monochrome)	G1-510c (color)
Sensor model	Sony IMX548-AAMJ	Sony IMX548-AAQJ
Resolution	Tbd: 2464 (H) × 2064 (V); 5.1 MP	
Sensor type	CMOS	
Shutter type	Global shutter (GS)	
Sensor size	Type 1/1.8; 6.75 mm × 5.66 mm; 8.8 mm diagonal	
Pixel size	2.74 μm × 2.74 μm	
CRA	0 deg	
Sensor bit depth (ADC)	12-bit	
Monochrome pixel formats	Mono8 (default), Mono10, Mono10p, Mono12, Mono12p	Mono8, Mono10, Mono10p, Mono12, Mono12p
YUV color pixel formats	Not applicable	YCbCr411_8_CbYYCrYY, YCbCr422_8_CbYCrY, YCbCr8_CbYCr
RGB color pixel formats	Not applicable	BayerRG8, BayerRG10, BayerRG10p, BayerRG12, BayerRG12p, BGR8, RGB8 (default)
Maximum frame rate	Tbd	
Exposure time	Tbd	
Exposure modes	Timed	
Gain	0 dB to 24 dB; 0.1 dB increments	
Digital binning	Horizontal: 1 to 8 columns; Vertical: 1 to 8 rows	
Image buffer (RAM)	32 MB	
Non-volatile memory (Flash)	1024 KB	
Inputs and outputs	1 opto-isolated input, 1 opto-isolated output, 2 non-isolated GPIOs ¹	
Power requirements	12 to 24 VDC	
Power requirements (PoE)	IEEE 802.3af	
Power consumption (typical)	Tbd	
Storage temperature	-20 °C to +85 °C ambient temperature	
Operating temperature	+5 °C to tbd (Housing), +5 °C to +85 °C (Mainboard ²)	
Humidity	0% to 80% humidity (non-condensing)	
Digital interface	1000BASE-T	
Camera controls	GenICam V2.0 (GenICam Access)	

¹ Use with external power only, not with PoE. See [I/Os and power supply by PoE](#) on page 34.

² Output by DeviceTemperature

Table 27: Alvium G1-510m/c specifications

Absolute QE

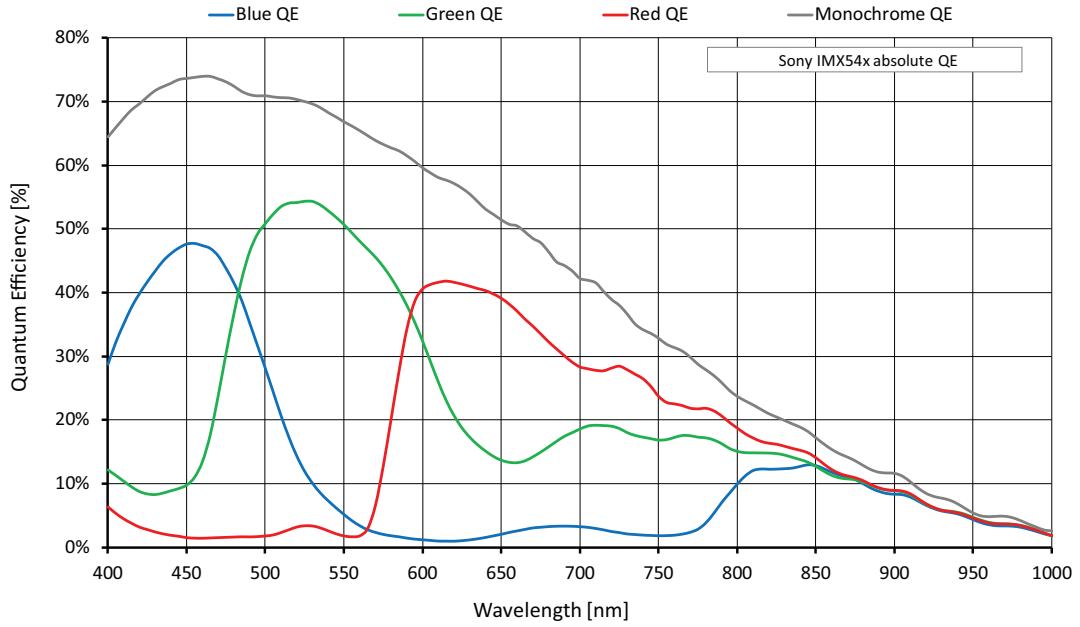

Figure 17: Alvium G1-510m/c (Sony IMX547) absolute QE

Spectral response

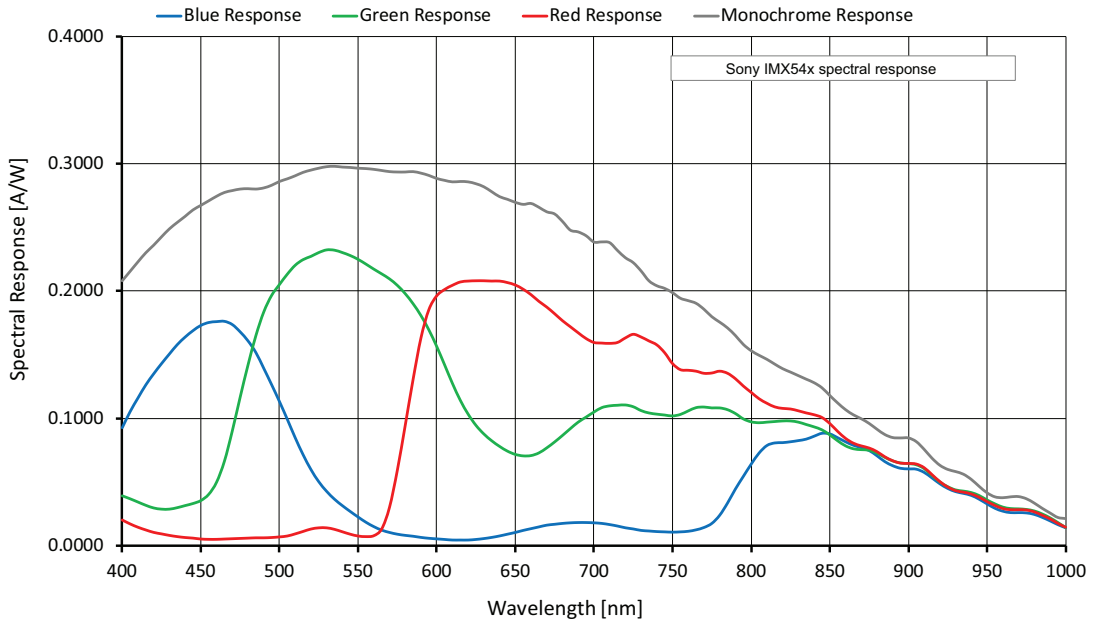

Figure 18: Alvium G1-510m/c (Sony IMX547) spectral response

ROI frame rates

Tables will be added in a future version of this document.

Alvium G1-811m/c

Feature	Specification	
	G1-811m	G1-811c
Sensor model	Sony IMX546-AAMJ	Sony IMX546-AAQJ
Resolution	2848 (H) × 2848 (V); 8.1 MP	
Sensor type	CMOS	
Shutter type	Global shutter (GS)	
Sensor size	Type 2/3; 7.8 mm × 7.8 mm; 11 mm diagonal	
Pixel size	2.74 μm × 2.74 μm	
CRA	0 deg	
Sensor bit depth (ADC)	12-bit	
Monochrome pixel formats	Mono8 (default), Mono10, Mono10p, Mono12, Mono12p	Mono8, Mono10, Mono10p, Mono12, Mono12p
YUV color pixel formats	Not applicable	YCbCr411_8_CbYYCrYY, YCbCr422_8_CbYCrY, YCbCr8_CbYCr
RGB color pixel formats	Not applicable	BayerRG8, BayerRG10, BayerRG10p, BayerRG12, BayerRG12p, BGR8, RGB8 (default)
Maximum frame rate	14 fps	
Exposure time	50 μs to 10 s	
Exposure modes	Timed	
Gain	0 dB to 24 dB; 0.1 dB increments	
Digital binning	Horizontal: 1 to 8 columns; Vertical: 1 to 8 rows	
Image buffer (RAM)	32 MB	
Non-volatile memory (Flash)	1024 KB	
Inputs and outputs	1 opto-isolated input, 1 opto-isolated output, 2 non-isolated GPIOs ¹	
Power requirements	12 to 24 VDC	
Power requirements (PoE)	IEEE 802.3af	
Power consumption (typical)	External power: 3.7 W at 12 VDC Power over Ethernet: 4.0 W	
Storage temperature	-20 °C to +85 °C ambient temperature	
Operating temperature	-20 °C to +50 °C (Housing), +5 °C to +85 °C (Mainboard ²)	
Humidity	0% to 80% humidity (non-condensing)	
Digital interface	1000BASE-T	
Camera controls	GenICam V2.0 (GenICam Access)	

¹ Use with external power only, not with PoE. See [I/Os and power supply by PoE](#) on page 34.

² Output by `DeviceTemperature`

Table 28: Alvium G1-811m/c specifications

Absolute QE

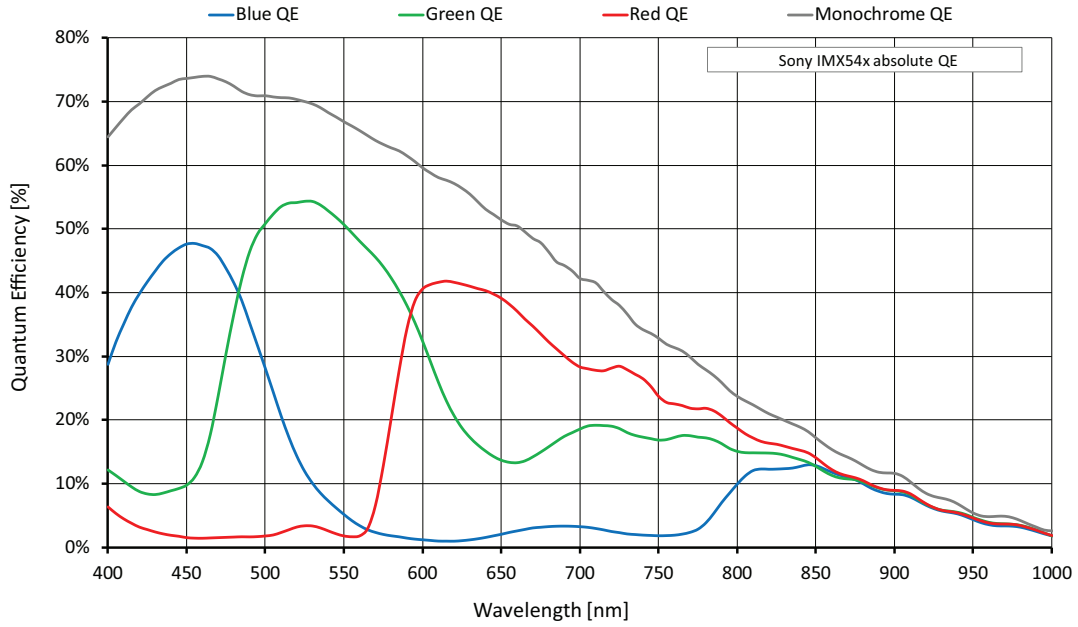

Figure 19: Alvium G1-811m/c (Sony IMX546) absolute QE

Spectral response

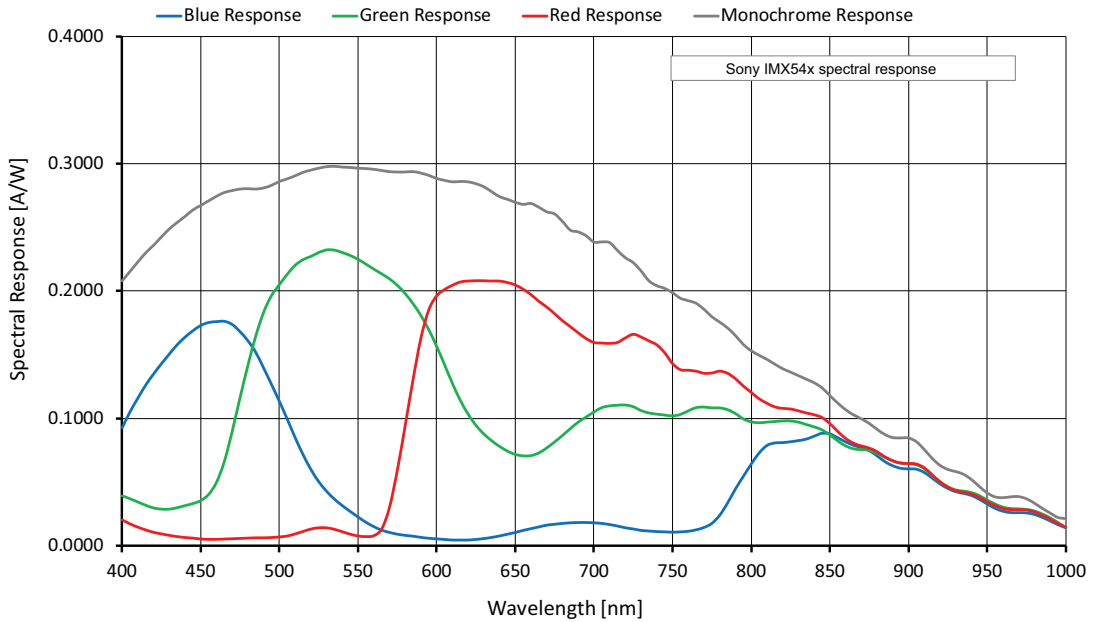

Figure 20: Alvium G1-811m/c (Sony IMX546) spectral response

ROI frame rates

Values are based on the conditions defined in [Operation for maximum frame rates](#) on page 43.

Currently, Alvium G1-811 models cannot be operated at 12 MBps.

Image format	Width [pixels]	Height [pixels]	ROI area [MP]	Frame rate [fps] ¹
				122 MBps
Full resolution	2848	2848	8.111	14.2 / 7.1
QSXGA	2560	2048	5.243	21.5 / 10.7
WQHD	2560	1440	3.686	29.6 / 14.8
QXGA	2048	1536	3.146	35.0 / 17.5
Full HD	1920	1080	2.074	50.9 / 25.6
UXGA	1600	1200	1.920	55.7 / 28.0
WXGA+	1440	900	1.296	79.0 / 39.7
SXGA	1280	1024	1.311	80.1 / 40.2
HD 720	1280	720	0.922	107.6 / 54.1
XGA	1024	768	0.786	127.6 / 64.1
SVGA	800	600	0.480	199.1 / 100.2
VGA	640	480	0.307	280.2 / 148.9
HVGA	480	320	0.154	373.1 / 208.3
QVGA	320	240	0.077	447.1 / 250.1
HQVGA	240	160	0.038	557.9 / 312.8
QQVGA	160	120	0.019	636.8 / 357.7
Max. × half	2848	1424	4.056	26.9 / 13.5
Max. × min.	2848	8	0.023	248.6 / 128.2
Min. × max.	8	2848	0.023	59.8 / 33.1
Min. × min.	8	8	64 P	1053.9 / 597.6

¹ Mono8 or Bayer...8⁽²⁾ at SensorBitDepth = 12-Bit /
Mono12 or Bayer...12 at SensorBitDepth = 12-Bit

² The three dots... represent the colors of a Bayer pixel format, such as in BayerRG8.

Table 29: Alvium G1-811m/c ROI frame rates

Alvium G1-1236m/c

Feature	Specification	
	G1-1236m (monochrome)	G1-1236c (color)
Sensor model	Sony IMX304	
Resolution	4112 (H) × 3008 (V); 12.4 MP	
Sensor type	CMOS	
Shutter type	Global shutter (GS)	
Sensor size	Type 1.1; 14.2 mm × 10.4 mm; 17.6 mm diagonal	
Pixel size	3.45 μm × 3.45 μm	
CRA	0 deg	
Sensor bit depth (ADC)	12-bit	
Monochrome pixel formats	Mono8 (default), Mono10, Mono10p, Mono12, Mono12p	Mono8, Mono10, Mono10p, Mono12, Mono12p
YUV color pixel formats	Not applicable	YCbCr411_8_CbYYCrYY, YCbCr422_8_CbYCrY, YCbCr8_CbYCr
RGB color pixel formats	Not applicable	BayerRG8, BayerRG10, BayerRG10p, BayerRG12, BayerRG12p, BGR8, RGB8 (default)
Maximum frame rate	9.6 fps	
Exposure time	83 μs to 10 s	
Exposure modes	Timed, TriggerControlled, TriggerWidth	
Gain	0 dB to 24 dB; 0.1 dB increments	
Digital binning ¹	Horizontal: 1 to 8 columns; Vertical: 1 to 8 rows	
Image buffer (RAM)	32 MB	
Non-volatile memory (Flash)	1024 KB	
Inputs and outputs	1 opto-isolated input, 1 opto-isolated output, 2 non-isolated GPIOs ²	
Power requirements	12 to 24 VDC	
Power requirements (PoE)	IEEE 802.3af	
Power consumption (typical)	External power: 3.8 W at 12 VDC Power over Ethernet: 4.0 W	
Storage temperature	-20 °C to +85 °C ambient temperature	
Operating temperature	-20 °C to +50 °C (Housing), +5 °C to +88 °C (Mainboard ³)	
Humidity	0% to 80% humidity (non-condensing)	
Digital interface	1000BASE-T	
Camera controls	GenICam V2.0 (GenICam Access)	

¹ Digital vertical binning can be used only when digital horizontal binning is used as well.

² Use with external power only, not with PoE. See [I/Os and power supply by PoE](#) on page 34.

³ Output by DeviceTemperature

Table 30: Alvium G1-1236m/c specifications

Absolute QE

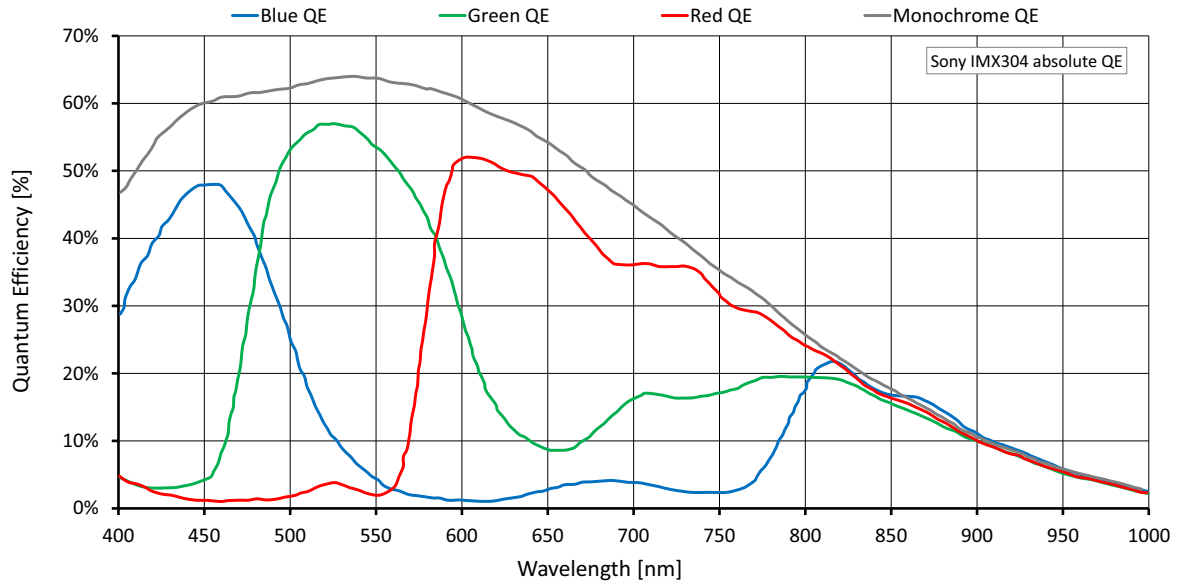

Figure 21: Alvim G1-1236m/c (Sony IMX304) absolute QE

Spectral response

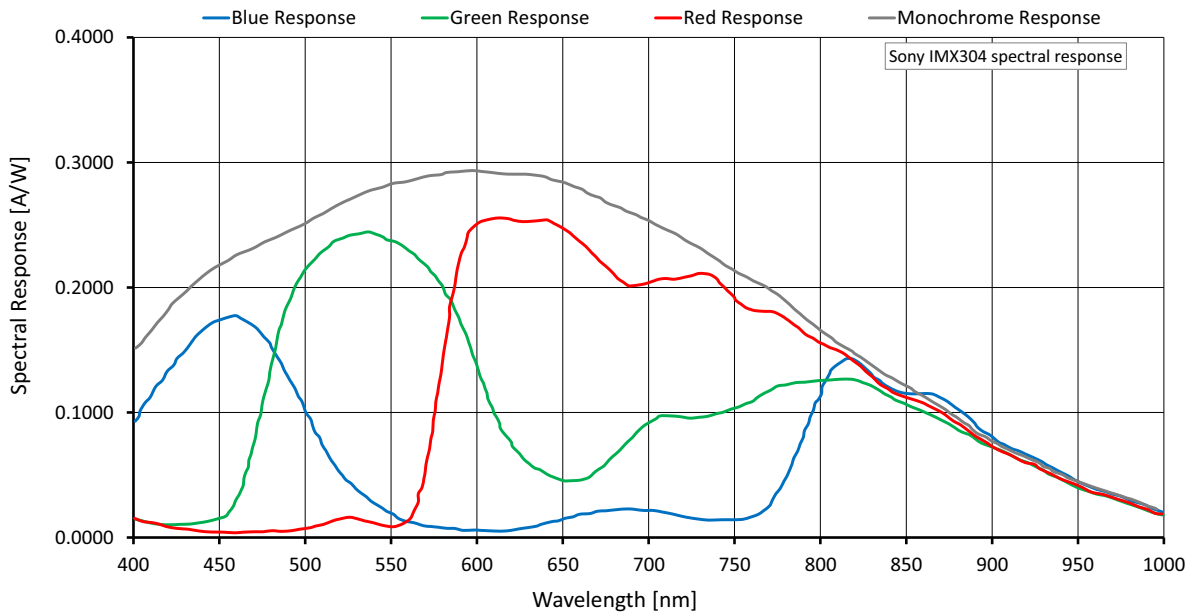

Figure 22: Alvim G1-1236m/c (Sony IMX304) spectral response

ROI frame rates

Values are based on the conditions defined in [Operation for maximum frame rates](#) on page 43.

Currently, Alvium G1-1236 models cannot be operated at 12 MBps.

Image format	Width [pixels]	Height [pixels]	ROI area [MP]	Frame rate [fps] ¹
				122 MBps
Full resolution	4112	3008	12.369	9.6 / 4.8
UHD 4K	3840	2160	8.294	14.3 / 7.1
QSXGA	2560	2048	5.243	22.5 / 11.3
WQHD	2560	1440	3.686	31.6 / 15.9
QXGA	2048	1536	3.146	37.2 / 18.7
Full HD	1920	1080	2.074	55.4 / 27.9
UXGA	1600	1200	1.920	56.3 / 30.3
WXGA+	1440	900	1.296	73.9 / 44.1
SXGA	1280	1024	1.311	65.5 / 44.0
HD 720	1280	720	0.922	91.1 / 61.3
XGA	1024	768	0.786	86.0 / 72.1
SVGA	800	600	0.480	108.2 / 108.2
VGA	640	480	0.307	132.9 / 132.9
HVGA	480	320	0.154	190.2 / 190.2
QVGA	320	240	0.077	242.7 / 242.7
HQVGA	240	160	0.038	335.5 / 335.5
QQVGA	160	120	0.019	413.5 / 413.5
Max. × half	4112	1504	6.184	18.9 / 9.4
Max. × min.	4112	8	0.033	405.6 / 228.0
Min. × max.	8	3008	0.024	23.2 / 23.2
Min. × min.	8	8	64 P	1185.3 / 1185.3

¹ Mono8 or Bayer...8⁽²⁾ at **SensorBitDepth** = 12-Bit /
Mono12 or Bayer...12 at **SensorBitDepth** = 12-Bit

² The three dots... represent the colors of a Bayer pixel format, such as in Bayer**RG8**.

Table 31: Alvium G1-1236m/c ROI frame rates

Alvium G1-1242m/c

Feature	Specification	
	G1-1242m (monochrome)	G1-1242c (color)
Sensor model	Sony IMX545-AAMJ	Sony IMX545-AAQJ
Resolution	4128 (H) × 3008 (V); 12.4 MP	
Sensor type	CMOS	
Shutter type	Global shutter (GS)	
Sensor size	Type 1/1.1; 11.31 mm × 8.24 mm; 14 mm diagonal	
Pixel size	2.74 μm × 2.74 μm	
CRA	0 deg	
Sensor bit depth (ADC)	12-bit	
Monochrome pixel formats	Mono8 (default), Mono10, Mono10p, Mono12, Mono12p	Mono8, Mono10, Mono10p, Mono12, Mono12p
YUV color pixel formats	Not applicable	YCbCr411_8_CbYYCrYY, YCbCr422_8_CbYCrY, YCbCr8_CbYCr
RGB color pixel formats	Not applicable	BayerRG8, BayerRG10, BayerRG10p, BayerRG12, BayerRG12p, BGR8, RGB8 (default)
Maximum frame rate	9.3 fps	
Exposure time	72 μs to 10 s	
Exposure modes	Timed	
Gain	0 dB to 24 dB; 0.1 dB increments	
Digital binning ¹	Horizontal: 1 to 8 columns; Vertical: 1 to 8 rows	
Image buffer (RAM)	32 MB	
Non-volatile memory (Flash)	1024 KB	
Inputs and outputs	1 opto-isolated input, 1 opto-isolated output, 2 non-isolated GPIOs ²	
Power requirements	12 to 24 VDC	
Power requirements (PoE)	IEEE 802.3af	
Power consumption (typical)	External power: 3.8 W at 12 VDC Power over Ethernet: 4.0 W	
Storage temperature	-20 °C to +85 °C ambient temperature	
Operating temperature	-20 °C to +50 °C (Housing), +5 °C to +85 °C (Mainboard ³)	
Humidity	0% to 80% humidity (non-condensing)	
Digital interface	1000BASE-T	
Camera controls	GenICam V2.0 (GenICam Access)	

¹ Digital vertical binning can be used only when digital horizontal binning is used as well.

² Use with external power only, not with PoE. See [I/Os and power supply by PoE](#) on page 34.

³ Output by `DeviceTemperature`

Table 32: Alvium G1-1242m/c specifications

Absolute QE

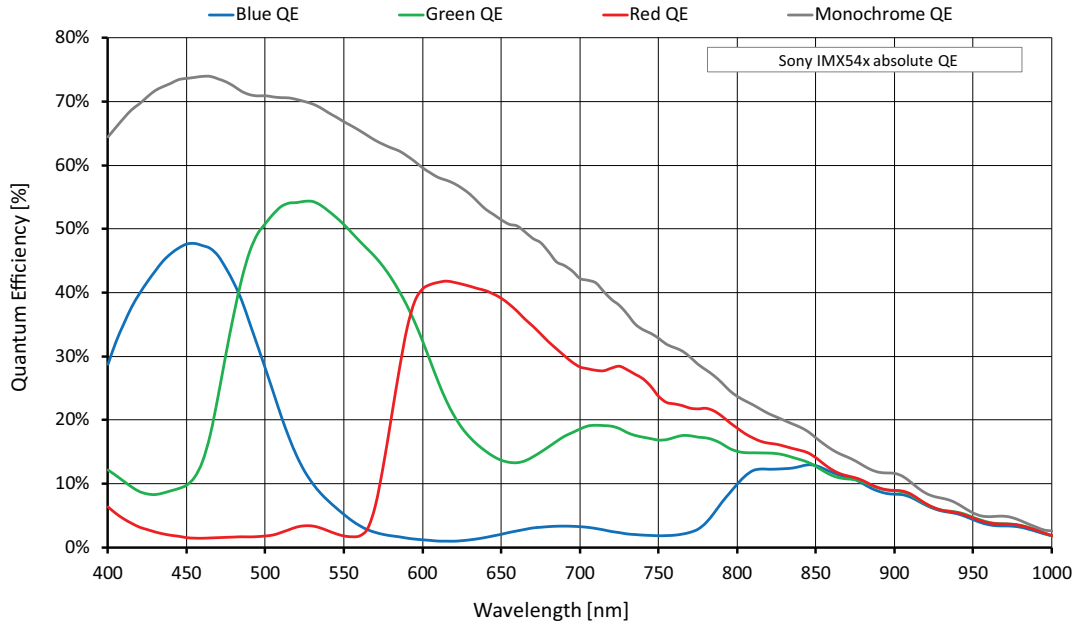

Figure 23: Alvium G1-1242m/c (Sony IMX545) absolute QE

Spectral response

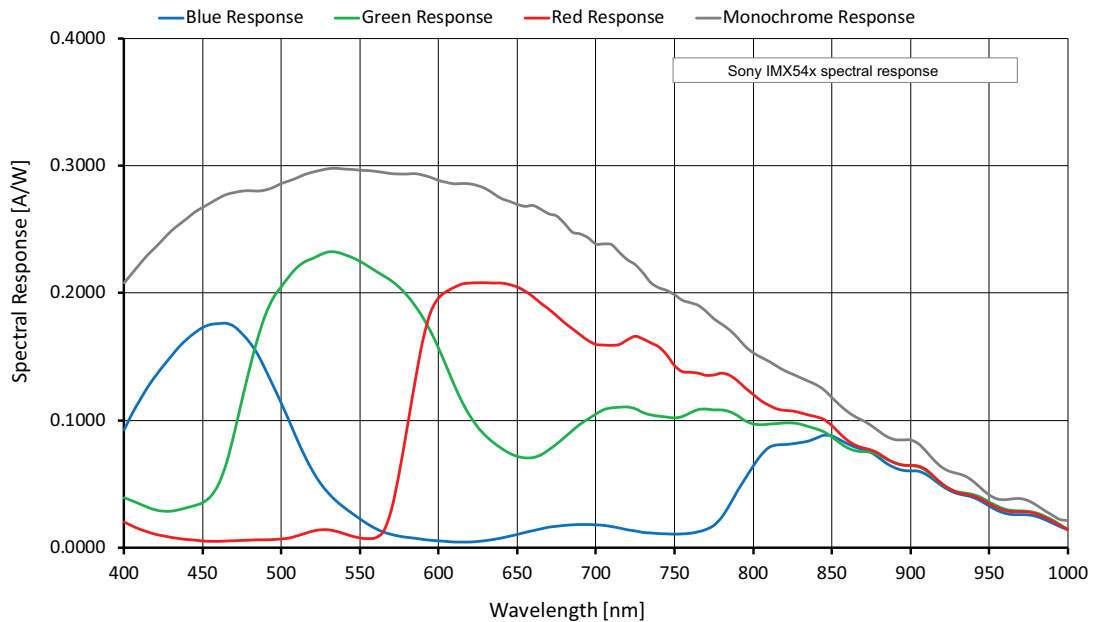

Figure 24: Alvium G1-1242m/c (Sony IMX545) spectral response

ROI frame rates

Values are based on the conditions defined in [Operation for maximum frame rates](#) on page 43.

Currently, Alvium G1-1242 models cannot be operated at 12 MBps.

Image format	Width [pixels]	Height [pixels]	ROI area [MP]	Frame rate [fps] ¹
				122 MBps
Full resolution	4128	3008	12.417	9.3 / 4.6
UHD 4K	3840	2160	8.294	13.8 / 6.8
QSXGA	2560	2048	5.243	21.7 / 10.9
WQHD	2560	1440	3.686	30.0 / 15.0
QXGA	2048	1536	3.146	35.3 / 17.7
Full HD	1920	1080	2.074	51.6 / 25.9
UXGA	1600	1200	1.920	56.4 / 28.4
WXGA+	1440	900	1.296	80.2 / 40.4
SXGA	1280	1024	1.311	81.2 / 40.8
HD 720	1280	720	0.922	109.7 / 55.1
XGA	1024	768	0.786	129.9 / 65.3
SVGA	800	600	0.480	175.2 / 102.4
VGA	640	480	0.307	209.2 / 152.8
HVGA	480	320	0.154	281.7 / 215.6
QVGA	320	240	0.077	340.4 / 260.6
HQVGA	240	160	0.038	430.0 / 329.4
QQVGA	160	120	0.019	495.2 / 379.5
Max. × half	4128	1504	6.209	17.9 / 8.9
Max. × min.	4128	8	0.033	189.2 / 97.8
Min. × max.	8	3008	0.024	41.5 / 31.7
Min. × min.	8	8	64 P	860.0 / 660.9

¹ Mono8 or Bayer...8⁽²⁾ at SensorBitDepth = 12-Bit / Mono12 or Bayer...12 at SensorBitDepth = 12-Bit

² The three dots... represent the colors of a Bayer pixel format, such as in Bayer**RG8**.

Table 33: Alvium G1-1242m/c ROI frame rates

Alvium G1-1620m/c

Feature	Specification	
	G1-1620m	G1-1620c
Sensor model	Sony IMX542-AAMJ	
Resolution	5328 (H) × 3040 (V); 16.2 MP	
Sensor type	CMOS	
Shutter type	Global shutter (GS)	
Sensor size	Type 1.1; 14.6 mm × 8.33 mm; 16.8 mm diagonal	
Pixel size	2.74 μm × 2.74 μm	
CRA	0 deg	
Sensor bit depth (ADC)	12-bit	
Monochrome pixel formats	Mono8 (default), Mono10, Mono10p, Mono12, Mono12p	Mono8, Mono10, Mono10p, Mono12, Mono12p
YUV color pixel formats	Not applicable	YCbCr411_8_CbYYCrYY, YCbCr422_8_CbYCrY, YCbCr8_CbYCr
RGB color pixel formats	Not applicable	BayerRG8, BayerRG10, BayerRG10p, BayerRG12, BayerRG12p, BGR8, RGB8 (default)
Maximum frame rate	7.2 fps	
Exposure time	91 μs to 10 s	
Exposure modes	Timed, TriggerControlled, TriggerWidth	
Gain	0 dB to 24 dB; 0.1 dB increments	
Digital binning ¹	Horizontal: 1 to 8 columns; Vertical: 1 to 8 rows	
Image buffer (RAM)	32 MB	
Non-volatile memory (Flash)	1024 KB	
Inputs and outputs	1 opto-isolated input, 1 opto-isolated output, 2 non-isolated GPIOs ²	
Power requirements	12 to 24 VDC	
Power requirements (PoE)	IEEE 802.3af	
Power consumption (typical)	External power: 3.7 W at 12 VDC Power over Ethernet: 4.1 W	
Storage temperature	-20 °C to +85 °C ambient temperature	
Operating temperature	-20 °C to +50 °C (Housing), +5 °C to +85 °C (Mainboard ³)	
Humidity	0% to 80% humidity (non-condensing)	
Digital interface	1000BASE-T	
Camera controls	GenICam V2.0 (GenICam Access)	

¹ Digital vertical binning can be used only when digital horizontal binning is used as well.

² Use with external power only, not with PoE. See [I/Os and power supply by PoE](#) on page 34.

³ Output by `DeviceTemperature`

Table 34: Alvium G1-1620m/c specifications

Absolute QE

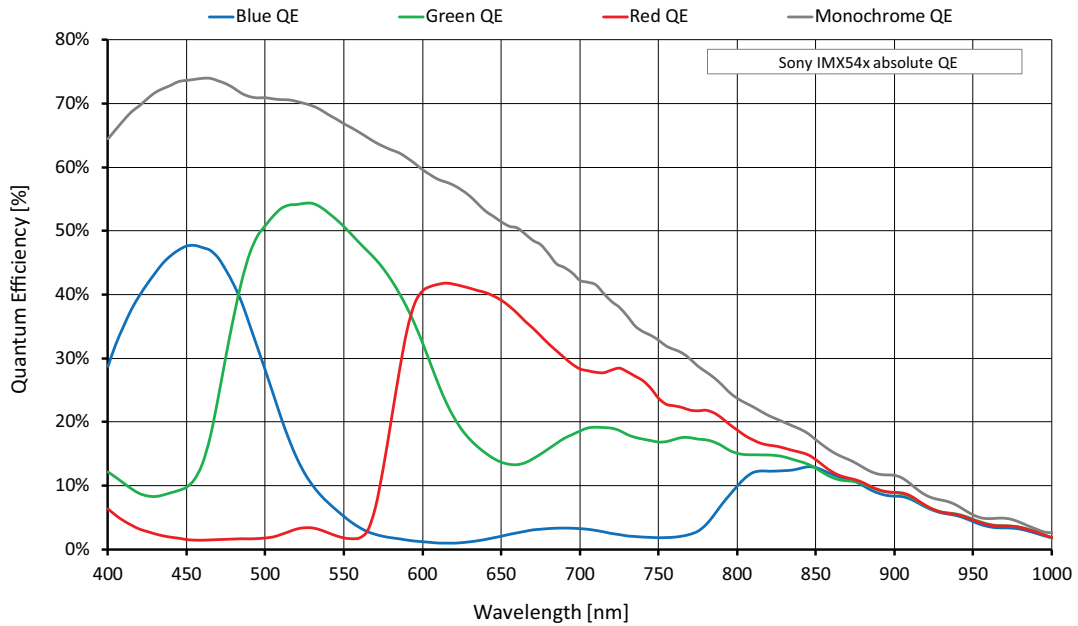

Figure 25: Alvium G1-1620m/c (Sony IMX542) absolute QE

Spectral response

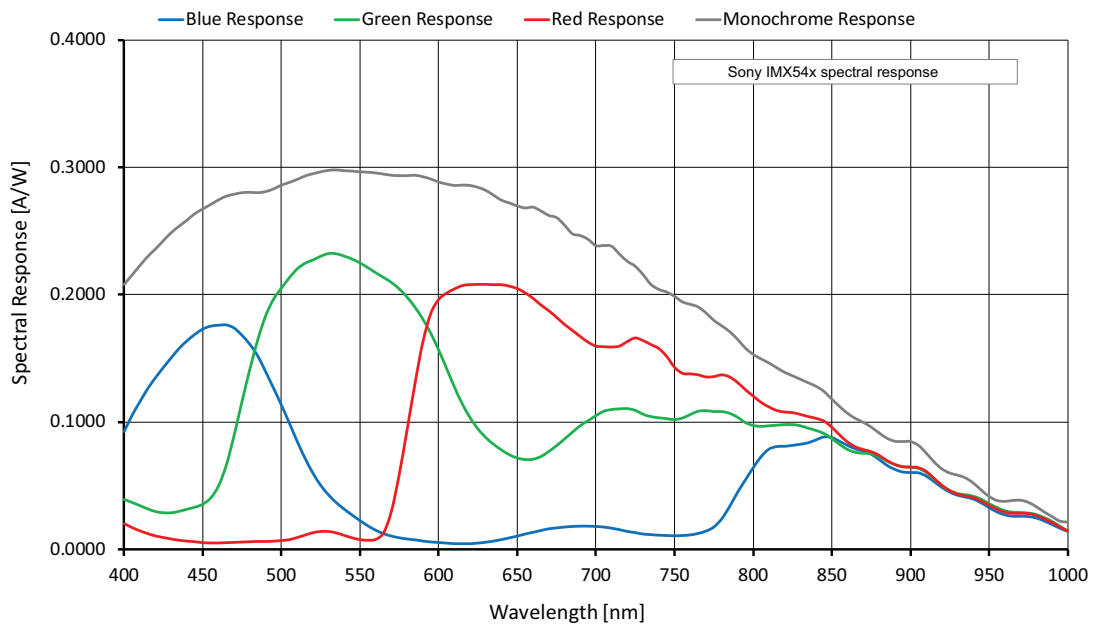

Figure 26: Alvium G1-1620m/c (Sony IMX542) spectral response

ROI frame rates

Values are based on the conditions defined in [Operation for maximum frame rates](#) on page 43.

Currently, Alvium G1-1620 models cannot be operated at 12 MBps.

Image format	Width [pixels]	Height [pixels]	ROI area [MP]	Frame rate [fps] ¹
				122 MBps
Full resolution	5312	3040	16.148	7.2 / 3.6
UHD 4K	3840	2160	8.294	13.9 / 6.9
QSXGA	2560	2048	5.243	21.9 / 11.0
WQHD	2560	1440	3.686	30.4 / 15.2
QXGA	2048	1536	3.146	35.8 / 17.9
Full HD	1920	1080	2.074	52.4 / 26.4
UXGA	1600	1200	1.920	57.3 / 28.8
WXGA+	1440	900	1.296	81.8 / 41.2
SXGA	1280	1024	1.311	82.6 / 41.5
HD 720	1280	720	0.922	112.3 / 56.5
XGA	1024	768	0.786	115.3 / 66.8
SVGA	800	600	0.480	142.2 / 105.2
VGA	640	480	0.307	171.0 / 157.9
HVGA	480	320	0.154	232.8 / 225.3
QVGA	320	240	0.077	284.1 / 274.9
HQVGA	240	160	0.038	364.4 / 352.6
QQVGA	160	120	0.019	424.4 / 410.7
Max. × half	5312	1520	8.074	13.9 / 6.9
Max. × min.	5312	8	0.042	168.7 / 87.6
Min. × max.	8	3040	0.024	32.6 / 31.6
Min. × min.	8	8	64 P	787.2 / 761.8

¹ Mono8 or Bayer...8⁽²⁾ at **SensorBitDepth** = 12-Bit / Mono12 or Bayer...12 at **SensorBitDepth** = 12-Bit

² The three dots... represent the colors of a Bayer pixel format, such as in Bayer**RG8**.

Table 35: Alvium G1-1620m/c ROI frame rates

Alvium G1-2040m/c

Feature	Specification	
	G1-2040m (monochrome)	G1-2040c (color)
Sensor model	Sony IMX541-AAMJ	Sony IMX541-AAQJ
Resolution	4512 (H) × 4512 (V); 20.4 MP	
Sensor type	CMOS	
Shutter type	Global shutter (GS)	
Sensor size	Type 1.1; 12.36 mm × 12.36 mm; 17.5 mm diagonal	
Pixel size	2.74 μm × 2.74 μm	
CRA	0 deg	
Sensor bit depth (ADC)	12-bit	
Monochrome pixel formats	Mono8 (default), Mono10, Mono10p, Mono12, Mono12p	Mono8, Mono10, Mono10p, Mono12, Mono12p
YUV color pixel formats	Not applicable	YCbCr411_8_CbYYCrYY, YCbCr422_8_CbYCrY, YCbCr8_CbYCr
RGB color pixel formats	Not applicable	BayerRG8, BayerRG10, BayerRG10p, BayerRG12, BayerRG12p, BGR8, RGB8 (default)
Maximum frame rate	5.8 fps	
Exposure time	78 μs to 10 s	
Exposure modes	Timed, TriggerControlled, TriggerWidth	
Gain	0 dB to 24 dB; 0.1 dB increments	
Digital binning ¹	Horizontal: 1 to 8 columns; Vertical: 1 to 8 rows	
Image buffer (RAM)	32 MB	
Non-volatile memory (Flash)	1024 KB	
Inputs and outputs	1 opto-isolated input, 1 opto-isolated output, 2 non-isolated GPIOs ²	
Power requirements	12 to 24 VDC	
Power requirements (PoE)	IEEE 802.3af	
Power consumption (typical)	External power: 3.8 W at 12 VDC Power over Ethernet: 4.2 W	
Storage temperature	-20 °C to +85 °C ambient temperature	
Operating temperature	-20 °C to +50 °C (Housing), +5 °C to +85 °C (Mainboard ³)	
Humidity	0% to 80% humidity (non-condensing)	
Digital interface	1000BASE-T	
Camera controls	GenICam V2.0 (GenICam Access)	
¹ Digital vertical binning can be used only when digital horizontal binning is used as well.		
² Use with external power only, not with PoE. See I/Os and power supply by PoE on page 34.		
³ Output by DeviceTemperature		

Table 36: Alvium G1-2040m/c specifications

Absolute QE

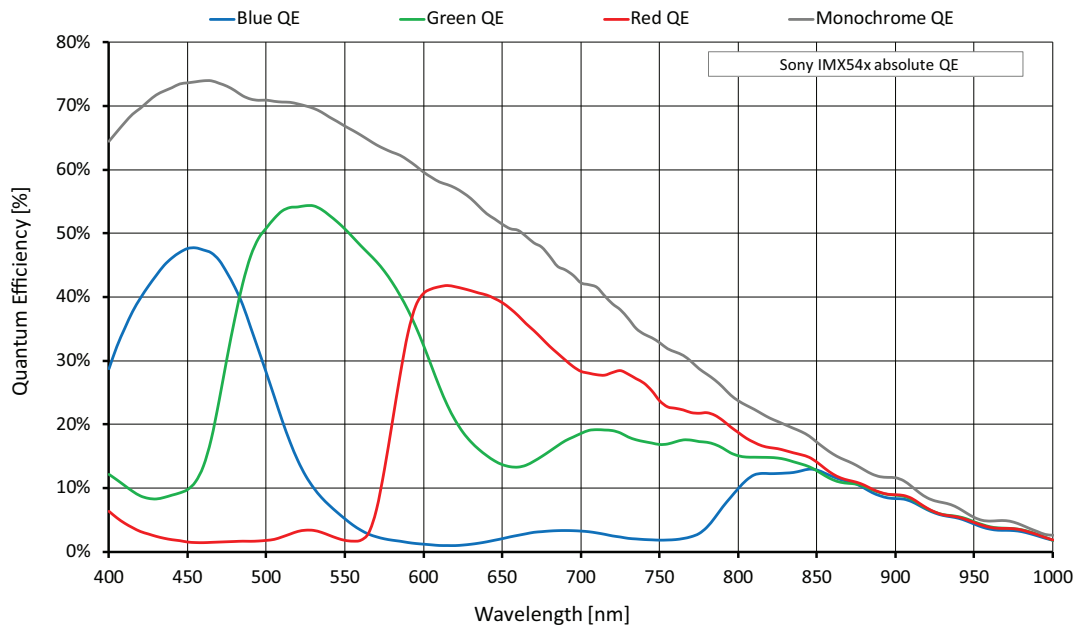

Figure 27: Alvium G1-2040m/c (Sony IMX541) absolute QE

Spectral response

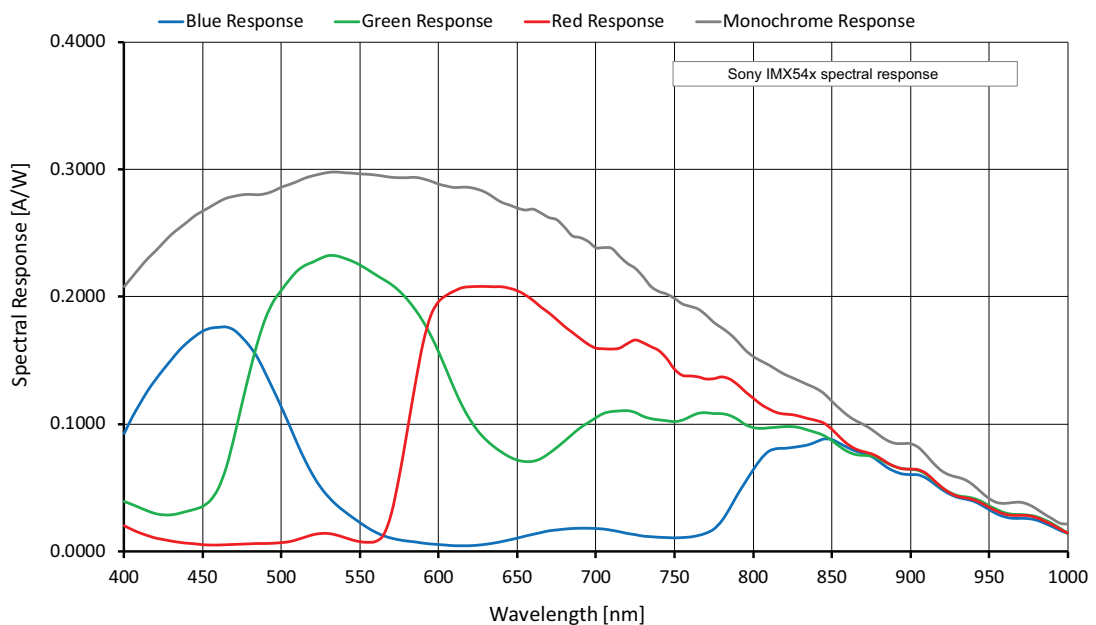

Figure 28: Alvium G1-2040m/c (Sony IMX541) spectral response

ROI frame rates

Values are based on the conditions defined in [Operation for maximum frame rates](#) on page 43.

Currently, Alvium G1-2040 models cannot be operated at 12 MBps.

Image format	Width [pixels]	Height [pixels]	ROI area [MP]	Frame rate [fps] ¹
				122 MBps
Full resolution	4512	4512	20.358	5.8 / 2.9
HXGA	4096	3072	12.583	9.2 / 4.6
UHD 4K	3840	2160	8.294	13.9 / 6.9
QSXGA	2560	2048	5.243	21.9 / 10.9
WQHD	2560	1440	3.686	30.3 / 15.2
QXGA	2048	1536	3.146	35.7 / 17.9
Full HD	1920	1080	2.074	52.4 / 26.3
UXGA	1600	1200	1.920	57.2 / 28.8
WXGA+	1440	900	1.296	81.6 / 41.1
SXGA	1280	1024	1.311	82.5 / 41.4
HD 720	1280	720	0.922	112.0 / 56.3
XGA	1024	768	0.786	132.5 / 66.6
SVGA	800	600	0.480	165.6 / 104.9
VGA	640	480	0.307	198.9 / 157.3
HVGA	480	320	0.154	270.3 / 224.3
QVGA	320	240	0.077	329.3 / 273.4
HQVGA	240	160	0.038	421.4 / 350.2
QQVGA	160	120	0.019	490.0 / 407.3
Max. × half	4512	2256	10.179	11.3 / 5.6
Max. × min.	4512	8	0.036	195.8 / 101.6
Min. × max.	8	4512	0.036	26.0 / 21.5
Min. × min.	8	8	64 P	899.5 / 750.4

¹ Mono8 or Bayer...8⁽²⁾ at SensorBitDepth = 12-Bit /
 Mono12 or Bayer...12 at SensorBitDepth = 12-Bit

² The three dots... represent the colors of a Bayer pixel format, such as in BayerRG8.

Table 37: Alvium G1-2040m/c ROI frame rates

Alvium G1-2050m/c

Feature	Specification	
	G1-2050m (monochrome)	G1-2050c (color)
Sensor model	Sony IMX183	
Resolution	5496 (H) × 3672 (V); 20.2 MP	
Sensor type	CMOS	
Shutter type	Rolling shutter (RS)	
Sensor size	Type 1; 13.1 mm × 8.8 mm; 15.86 mm diagonal	
Pixel size	2.4 μm × 2.4 μm	
CRA	3 deg	
Sensor bit depth (ADC)	10-bit	
Monochrome pixel formats	Mono8 (default), Mono10, Mono10p	Mono8, Mono10, Mono10p
YUV color pixel formats	Not applicable	YCbCr411_8_CbYYCrYY, YCbCr422_8_CbYCrY, YCbCr8_CbYCr
RGB color pixel formats	Not applicable	BayerGR8, BayerGR10, BayerGR10p, BGR8, RGB8 (default)
Maximum frame rate ¹	5.9 fps	
Exposure time	48 μs to 10 s	
Exposure modes	Timed	
Gain	0 dB to 27 dB; 0.1 dB increments	
Digital binning ²	Horizontal: 1 to 8 columns; Vertical: 1 to 8 rows	
Image buffer (RAM)	32 MB	
Non-volatile memory (Flash)	1024 KB	
Inputs and outputs	1 opto-isolated input, 1 opto-isolated output, 2 non-isolated GPIOs ³	
Power requirements	12 to 24 VDC	
Power requirements (PoE)	IEEE 802.3af	
Power consumption (typical)	External power: 3.6 W at 12 VDC Power over Ethernet: 3.9 W	
Storage temperature	-20 °C to +85 °C ambient temperature	
Operating temperature	-20 °C to +55 °C (Housing), +5 °C to +88 °C (Mainboard ⁴)	
Humidity	0% to 80% humidity (non-condensing)	
Digital interface	1000BASE-T	
Camera controls	GenICam V2.0 (GenICam Access)	

¹ In triggered mode: 2.5 fps

² Digital vertical binning can be used only when digital horizontal binning is used as well.

³ Use with external power only, not with PoE. See [I/Os and power supply by PoE](#) on page 34.

⁴ Output by `DeviceTemperature`

Table 38: Alvium G1-2050m/c specifications

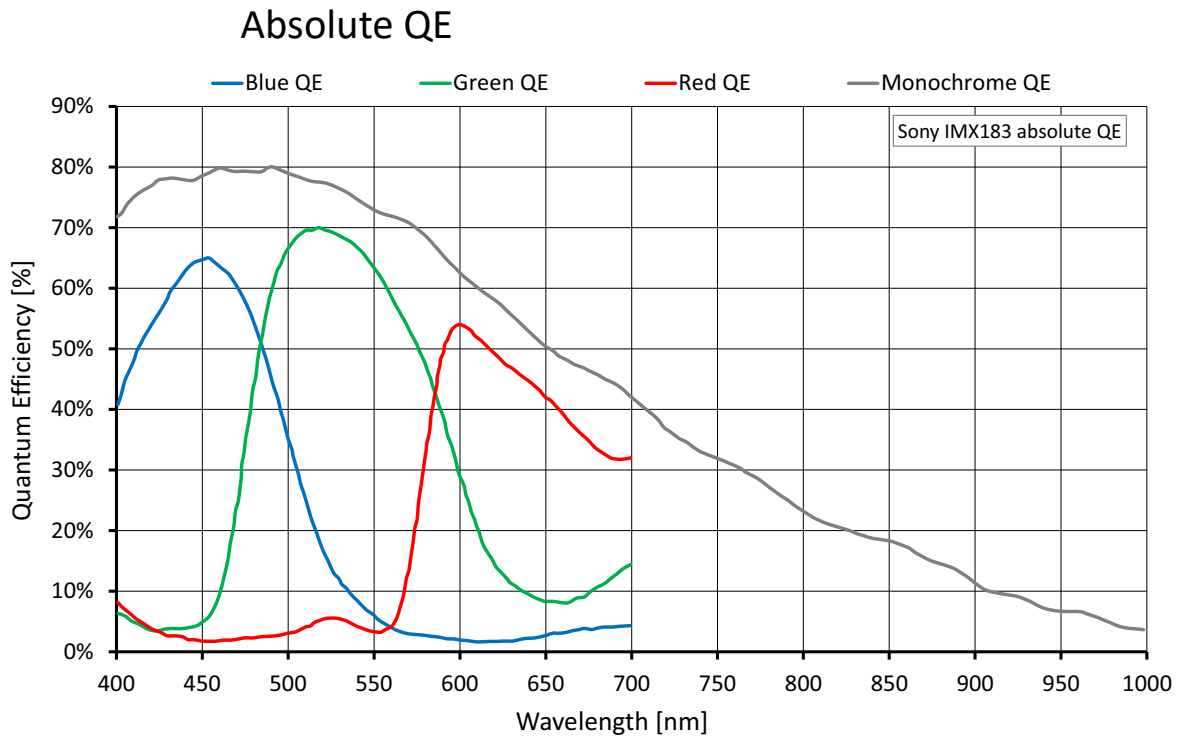

Figure 29: Alvium G1-2050m/c (Sony IMX183) absolute QE

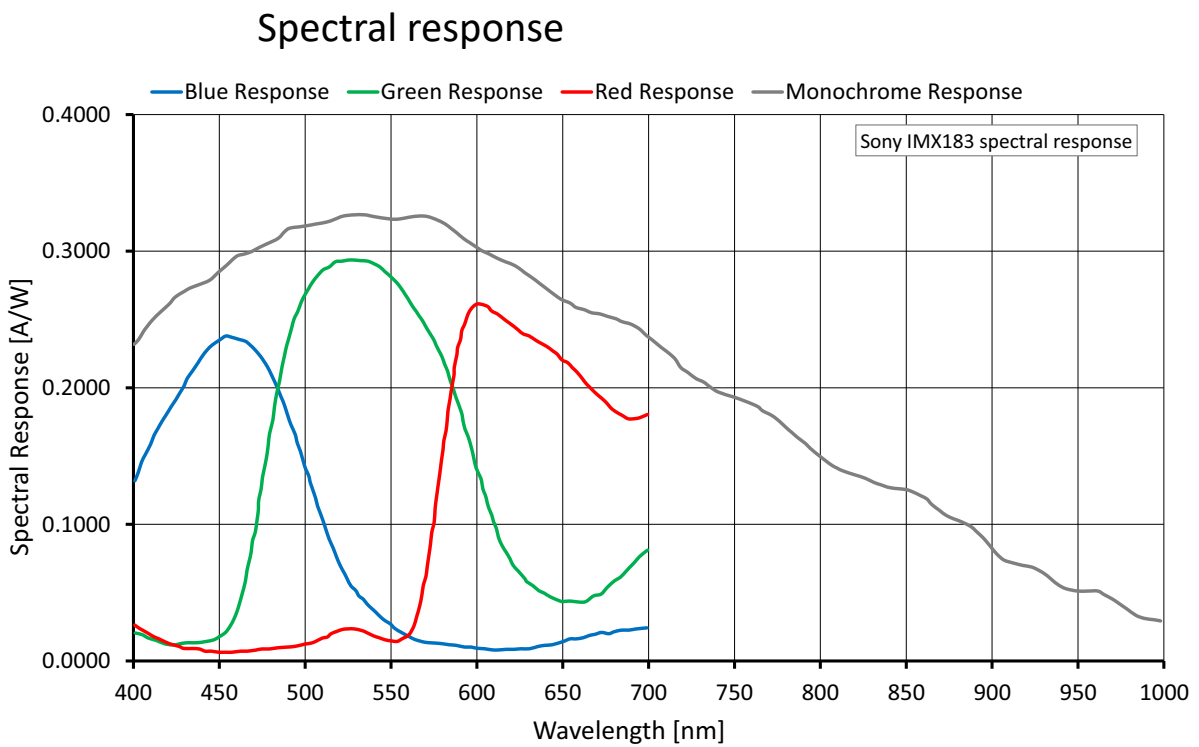

Figure 30: Alvium G1-2050m/c (Sony IMX183) spectral response

ROI frame rates

Values are based on the conditions defined in [Operation for maximum frame rates](#) on page 43.

In GRS mode, the values for maximum frame rate reached in RS mode apply to all resolutions. **In triggered mode**, the values for maximum frame rate reached in free run mode are cut in half.

Currently, Alvium G1-2050 models cannot be operated at 12 MBps.

Image format	Width [pixels]	Height [pixels]	ROI area [MP]	Frame rate [fps] ¹
				122 MBps
Full resolution	5496	3672	20.181	5.9 / 2.9
HXGA	4096	3072	12.583	7.0 / 3.5
UHD 4K	3840	2160	8.294	9.9 / 4.9
QSXGA	2560	2048	5.243	10.4 / 5.2
WQHD	2560	1440	3.686	11.5 / 5.7
QXGA	2048	1536	3.146	11.5 / 5.7
Full HD	1920	1080	2.074	11.5 / 5.7
UXGA	1600	1200	1.920	11.5 / 5.7
WXGA+	1440	900	1.296	11.5 / 5.7
SXGA	1280	1024	1.311	11.5 / 5.7
HD 720	1280	720	0.922	11.5 / 5.7
XGA	1024	768	0.786	11.5 / 5.7
SVGA	800	600	0.480	11.5 / 5.7
VGA	640	480	0.307	11.5 / 5.7
HVGA	480	320	0.154	11.5 / 5.7
QVGA	320	240	0.077	11.5 / 5.7
HQVGA	240	160	0.038	11.5 / 5.7
QQVGA	160	120	0.019	11.5 / 5.7
Max. × half	5496	1836	10.091	11.5 / 5.7
Max. × min.	5496	8	0.044	11.5 / 5.7
Min. × max.	8	3672	0.029	5.9 / 2.9
Min. × min.	8	8	64 P	11.5 / 5.7

¹ Mono8 or Bayer...8⁽²⁾ at SensorBitDepth = 10-Bit /
Mono10 or Bayer...10 at SensorBitDepth = 10-Bit

² The three dots... represent the colors of a Bayer pixel format, such as in BayerRG8.

Table 39: Alvium G1-2050m/c ROI frame rates

Alvium G1-2460m/c

Feature	Specification	
	G1-2460m	G1-2460c
Sensor model	Sony IMX540-AAMJ	Sony IMX540-AAQJ
Resolution	5328 (H) × 4608 (V); 24.6 MP	
Sensor type	CMOS	
Shutter type	Global shutter (GS)	
Sensor size	Type 1.2; 14.60 mm × 12.63 mm; 19.3 mm diagonal	
Pixel size	2.74 μm × 2.74 μm	
CRA	0 deg	
Sensor bit depth (ADC)	12-bit	
Monochrome pixel formats	Mono8 (default), Mono10, Mono10p, Mono12, Mono12p	Mono8, Mono10, Mono10p, Mono12, Mono12p
YUV color pixel formats	Not applicable	YCbCr411_8_CbYYCrYY, YCbCr422_8_CbYCrY, YCbCr8_CbYCr
RGB color pixel formats	Not applicable	BayerRG8, BayerRG10, BayerRG10p, BayerRG12, BayerRG12p, BGR8, RGB8 (default)
Maximum frame rate	4.8 fps	
Exposure time	92 μs to 10 s	
Exposure modes	Timed, TriggerControlled, TriggerWidth	
Gain	0 dB to 24 dB; 0.1 dB increments	
Digital binning ¹	Horizontal: 1 to 8 columns; Vertical: 1 to 8 rows	
Image buffer (RAM)	32 MB	
Non-volatile memory (Flash)	1024 KB	
Inputs and outputs	1 opto-isolated input, 1 opto-isolated output, 2 non-isolated GPIOs ²	
Power requirements	12 to 24 VDC	
Power requirements (PoE)	IEEE 802.3af	
Power consumption (typical) ³	External power: 4.0 W at 12 VDC Power over Ethernet: 4.4 W	
Storage temperature	-20 °C to +85 °C ambient temperature	
Operating temperature	-20 °C to +50 °C (Housing), +5 °C to +85 °C (Mainboard ³)	
Humidity	0% to 80% humidity (non-condensing)	
Digital interface	1000BASE-T	
Camera controls	GenICam V2.0 (GenICam Access)	

¹ Digital vertical binning can be used only when digital horizontal binning is used as well.

² Use with external power only, not with PoE. See [I/Os and power supply by PoE](#) on page 34.

³ Output by `DeviceTemperature`

Table 40: Alvium G1-2460m/c specifications

Absolute QE

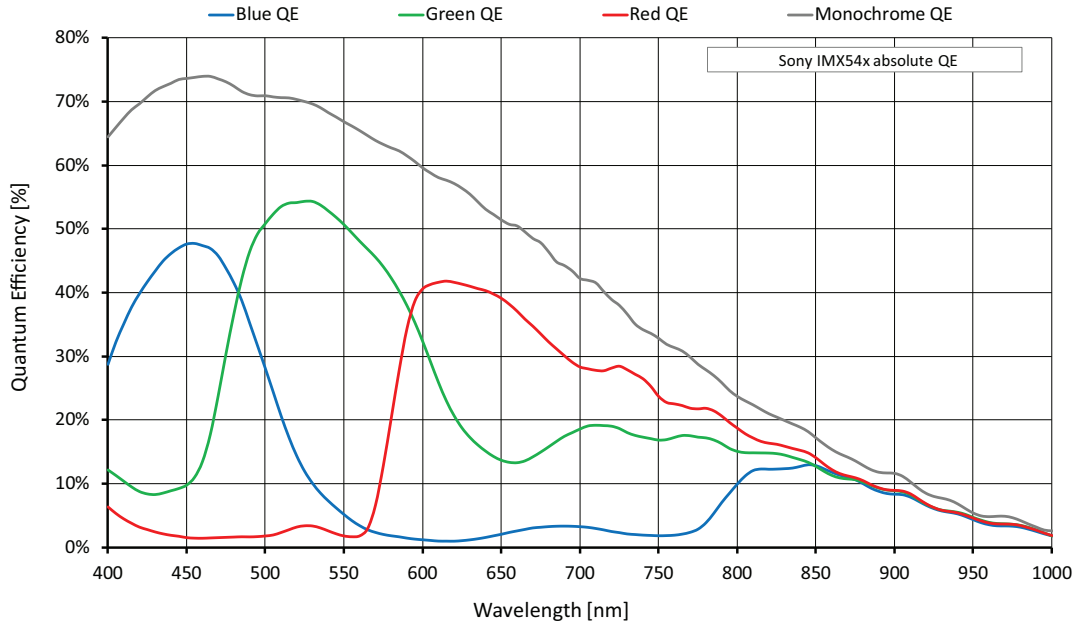

Figure 31: Alvium G1-2460m/c (Sony IMX540) absolute QE

Spectral response

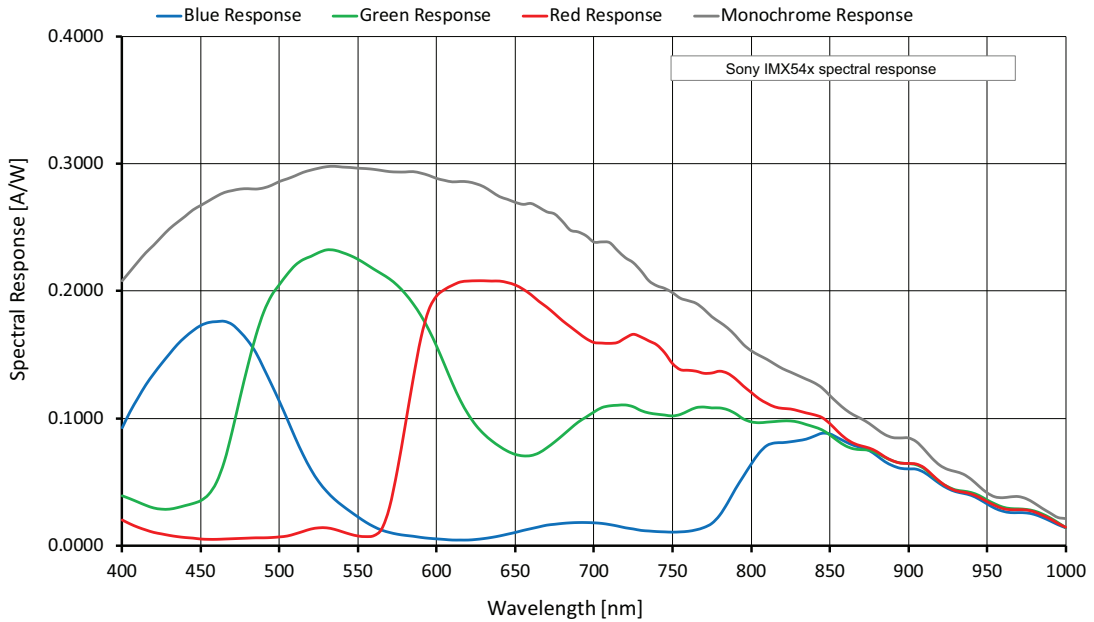

Figure 32: Alvium G1-2460m/c (Sony IMX540) spectral response

ROI frame rates

Values are based on the conditions defined in [Operation for maximum frame rates](#) on page 43.

When rolling shutter cameras are **operated in triggered mode**, the values for maximum frame rate reached in free run mode are cut in half.

Currently, Alvium G1-2460 models cannot be operated at 12 MBps.

Image format	Width [pixels]	Height [pixels]	ROI area [MP]	Frame rate [fps] ¹
				122 MBps
Full resolution	5328	4608	24.551	4.8 / 2.4
HSXGA	5120	4096	20.972	5.6 / 2.8
HXGA	4096	3072	12.583	9.3 / 4.6
UHD 4K	3840	2160	8.294	13.9 / 6.9
QSXGA	2560	2048	5.243	21.9 / 11.0
WQHD	2560	1440	3.686	30.4 / 15.2
QXGA	2048	1536	3.146	35.8 / 17.9
Full HD	1920	1080	2.074	52.4 / 26.4
UXGA	1600	1200	1.920	57.3 / 28.8
WXGA+	1440	900	1.296	81.8 / 41.2
SXGA	1280	1024	1.311	82.6 / 41.5
HD 720	1280	720	0.922	112.3 / 56.5
XGA	1024	768	0.786	115.3 / 66.8
SVGA	800	600	0.480	142.2 / 105.2
VGA	640	480	0.307	171.0 / 157.9
HVGA	480	320	0.154	232.8 / 225.3
QVGA	320	240	0.077	284.1 / 274.9
HQVGA	240	160	0.038	364.4 / 352.6
QQVGA	160	120	0.019	424.4 / 410.7
Max. × half	5328	2304	12.276	9.4 / 4.7
Max. × min.	5328	8	0.043	168.3 / 87.4
Min. × max.	8	4608	0.037	21.8 / 21.1
Min. × min.	8	8	64 P	787.2 / 761.8

¹ Mono8 or Bayer...8⁽²⁾ at SensorBitDepth = 10-Bit /
 Mono10 or Bayer...10 at SensorBitDepth = 10-Bit

² The three dots... represent the colors of a Bayer pixel format, such as in BayerRG8.

Table 41: Alvium G1-2460m/c ROI frame rates

White balance default

Alvium G1 color cameras are balanced for neutral color reproduction with an illumination of 5000 °K (warm daylight). [Table 42](#) shows default values for the red and blue channel by model.

For different illuminations, use auto white balance or adapt the color channel values manually.



Feature descriptions and firmware downloads

Alvium Features Reference: www.alliedvision.com/en/support/technical-documentation/alvium-gige-documentation

Firmware downloads: www.alliedvision.com/en/support/firmware-downloads.

Alvium G1 model	Sensor model	Red channel value	Blue channel value
Alvium G1-040c	Sony IMX287	2.360	2.030
Alvium G1-158c	Sony IMX273	2.355	2.100
Alvium G1-234c	Sony IMX249	2.580	1.810
Alvium G1-240c	Sony IMX392	2.355	2.100
Alvium G1-319c	Sony IMX265	2.355	2.100
Alvium G1-500c	ON Semiconductor AR0521SR	2.120	1.520
Alvium G1-507c	Sony IMX264	2.355	2.100
Alvium G1-510c	Sony IMX548	tbd	tbd
Alvium G1-811c	Sony IMX546	2.870	2.000
Alvium G1-1236c	Sony IMX304	2.355	2.100
Alvium G1-1242c	Sony IMX545	2.870	2.000
Alvium G1-1620c	Sony IMX542	2.870	2.000
Alvium G1-2040c	Sony IMX541	2.870	2.000
Alvium G1-2050c	Sony IMX183	2.660	1.830
Alvium G1-2460c	Sony IMX540	2.870	2.000

Table 42: Alvium G1 default values for color channels



Monochrome and VSWIR models

White balance default does not apply to monochrome and VSWIR models.

Dimensions and mass

Feature	C-Mount	CS-Mount	S-Mount
Flange focal distance, optical [mm]	17.526	12.526	12.63
Thread [mm]	1"-32tpi UNS-2B	1"-32tpi UNS-2B	M12 × 0.5
Maximum protrusion ¹ [mm]	13.6	8.6	11.0
Body dimensions (L × W × H [mm])	41 × 29 × 29	36 × 29 × 29	36 × 29 × 29
Mass	65 g	65 g	65 g

¹For details, see [Lens mounts and maximum protrusion](#).

Table 43: Dimensions and mass

Technical drawings

C-Mount

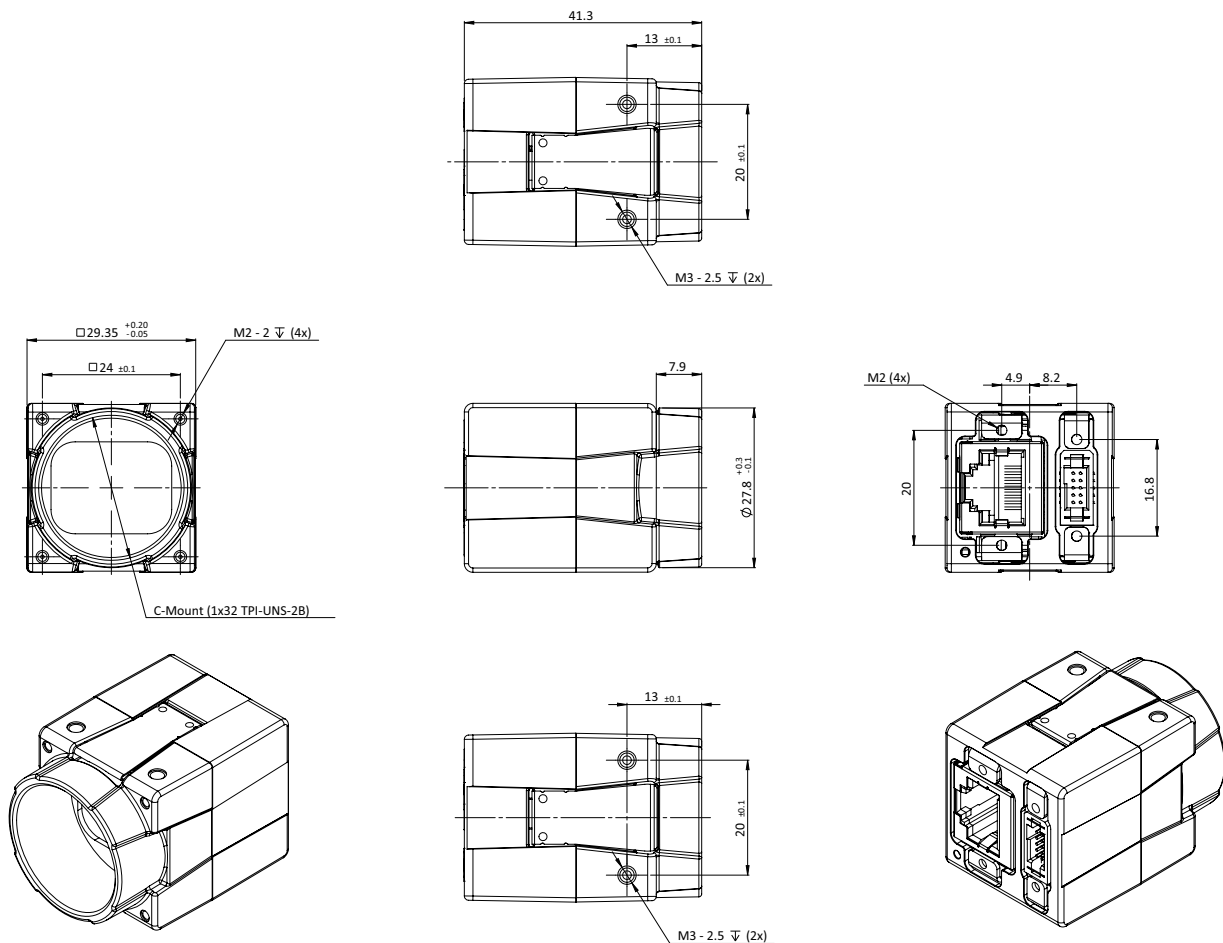

Figure 33: Dimensions for C-Mount models

CS-Mount

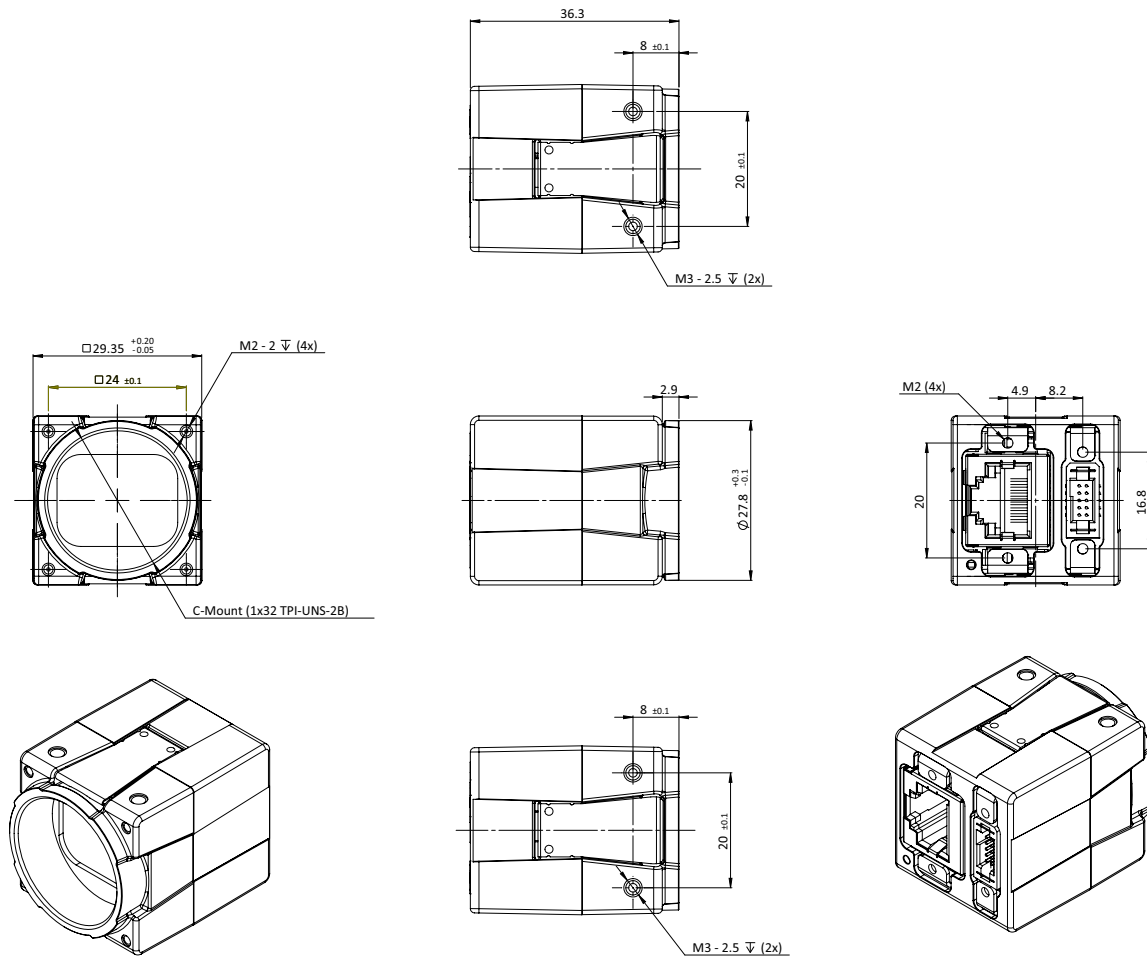

Figure 34: Dimensions for CS-Mount models

S-Mount

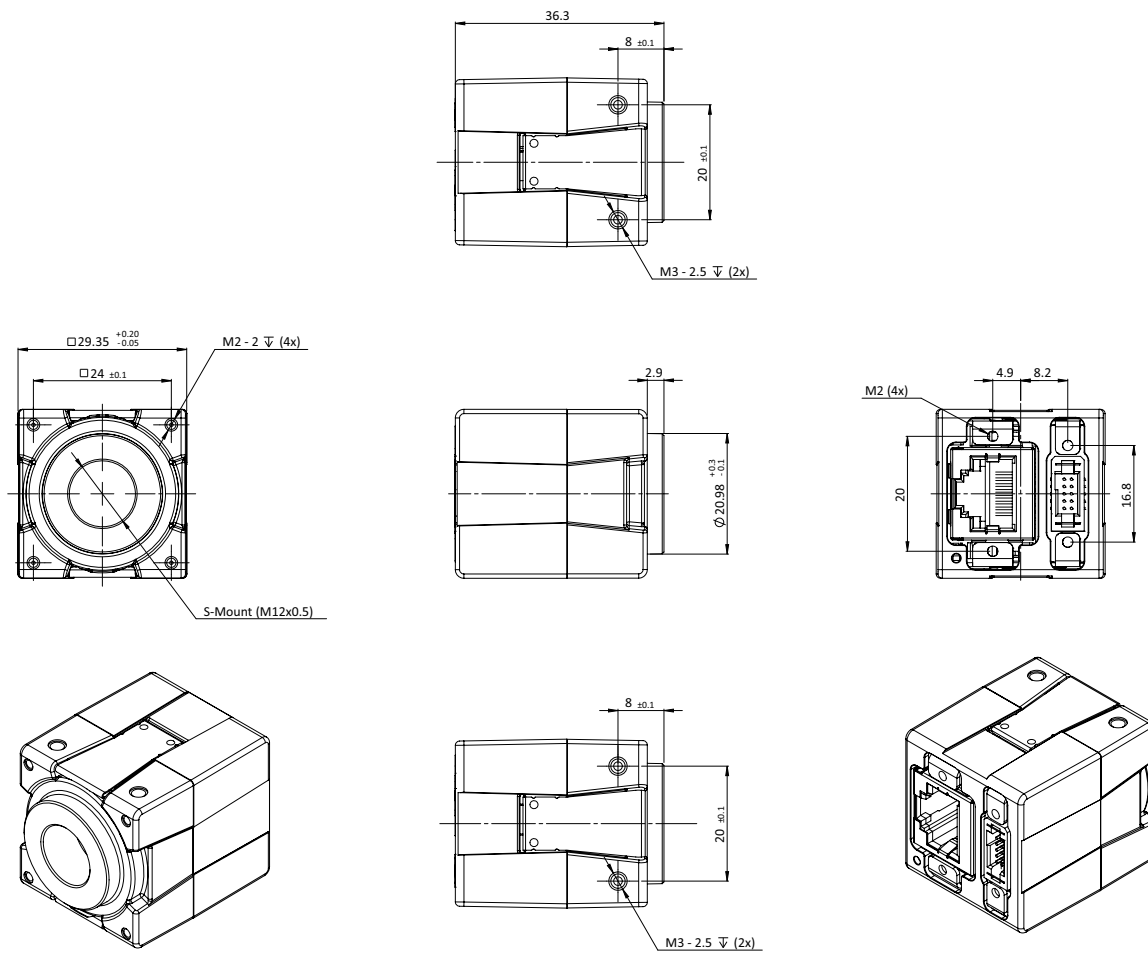

Figure 35: Dimensions for S-Mount models

Lens mounts and maximum protrusion



No need to readjust lens mounts

Alvium G1 camera mounts are adjusted with high precision during manufacturing. Construction ensures permanent accuracy without need to readjust.

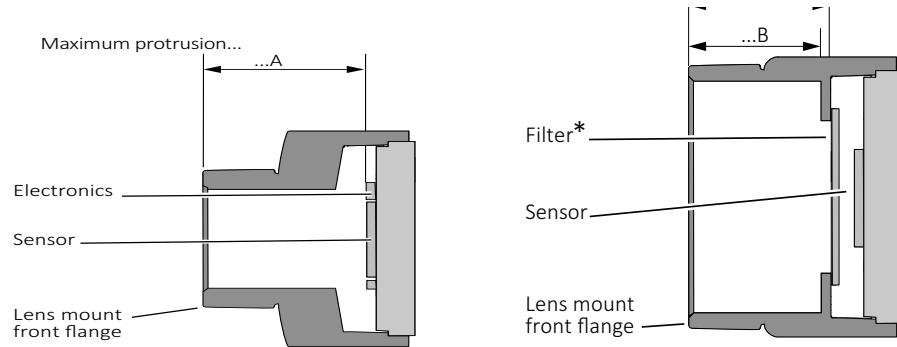

*Only color models are equipped with an IR cut filter

Figure 36: Maximum protrusion S-Mount (left); CS-Mount and C-Mount (right)

Figure 36 shows schematics for maximum protrusion of lenses, Table 44 shows values for maximum protrusion.



NOTICE

Damage to sensor or optics by unsuitable lenses

The sensor, filter, or lens can be damaged if a lens exceeding maximum protrusion is mounted to the camera.

- Use lenses with less than the allowed maximum protrusion, see Table 44.
- See [Mounting the lens](#) on page 116.
- For S-Mount lenses, see [Mounting and focusing S-Mount lenses](#) on page 117.

Mount	Maximum protrusion
C-Mount	13.6 mm
CS-Mount	8.6 mm
S-Mount	11.0 mm

Table 44: Maximum protrusion for Alvium G1 cameras

IR cut filter

The following table shows which Alvium G1 models are equipped with an IR cut filter. The filter is permanently installed and cannot be removed.

Color or monochrome model	S-Mount	CS-Mount	C-Mount
Color	No filter	Type Hoya C5000 IR cut filter	
Monochrome	No filter		

Table 45: Optical filters availability

Cameras **without** IR cut filter have a higher sensitivity for low-light imaging. Moreover, spectral sensitivity is increased.

Cameras **with** IR cut filter are more accurate in reproduction of color, contrast, and sharpness, as the filter absorbs near-IR wavelengths. See [Figure 37](#) for filter transmission.



Spectral transmission values

The following curve shows typical transmission for type Hoya C5000 IR cut filter. Values may vary slightly by filter lot.

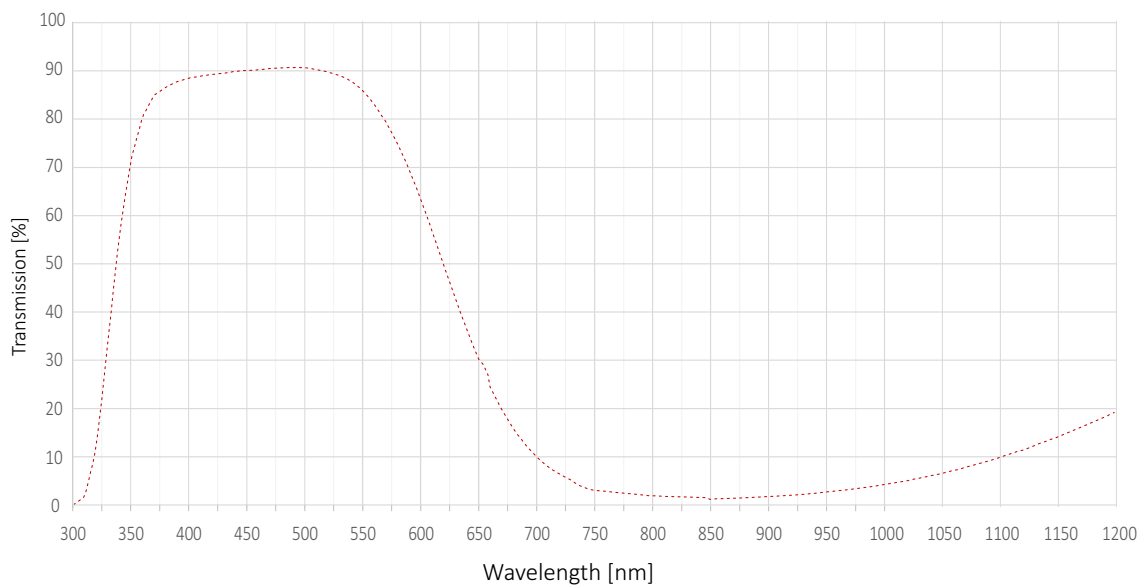

Figure 37: Spectral transmission for type Hoya C5000 IR cut filter (exemplary curve)



S-Mount lenses with IR cut design

For improved image quality, we recommend using S-Mount lenses that are IR- optimized or that have IR cut coating. See the S-Mount Lenses User Guide at www.alliedvision.com/fileadmin/content/documents/products/accessories/lenses/Allied_Vision/User_Guide/S-Mount-Lenses_User-Guide.pdf.

Sensor position accuracy

Sensor shift and rotation

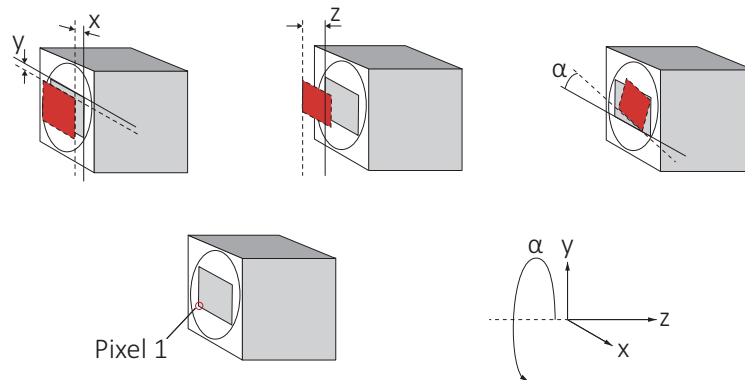

Gray rectangle: Reference sensor position **Red rectangle:** Current position
Straight line: Reference edge **Dotted line:** Current reference edge

The orientation of the z-axis deviates from scientific conventions to define tolerances of the flange focal distance.

Figure 38: Sensor shift and rotation

The following table defines the manufacturing accuracy for sensor positioning.

Criteria	Subject	Properties
Alignment method		Optical alignment of the photosensitive sensor area into the camera front module (lens mount front flange)
Reference Points	Sensor	Center of the pixel area (photo sensitive cells)
	Camera	Center of the lens mount
Accuracy	x/y-axis ^{1,2}	±150 µm (sensor shift)
	z	0 to -100 µm (optical back focal length)
	α^1	±0.5 deg (sensor rotation as the deviation from the parallel to the camera bottom)

¹ We cannot measure or guarantee these values for **non-standard S-Mount hardware options** that are manufactured on customer request for: Alvium G1-234, G1-507, G1-811, G1-1236, G1-1242, G1-1620, G1-2040, G1-2050, and G1-2460.

² For Alvium 1800 G1-2050 models, the complete offset is ±200 µm, common tolerances do not have to be added.

Table 46: Alvium G1 cameras, criteria of sensor position accuracy

Sensor tilt

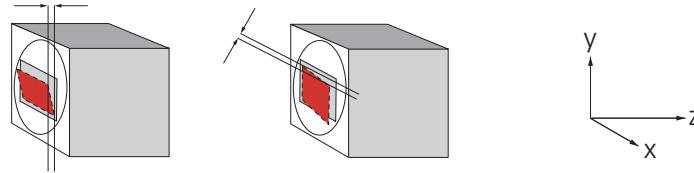

Gray rectangle: Reference sensor position **Red rectangle:** Current position

Figure 39: Sensor tilt

The following table defines sensor tilt as the variance between highest and lowest pixel of a sensor along the z-axis, measured in micrometers.

Alvium G1 model	Pixel size	Maximum tilt
Alvium G1-040m/c	6.9 μm \times 6.9 μm	95 μm
Alvium G1-158m/c	3.45 μm \times 3.45 μm	24 μm
Alvium G1-234m/c	5.86 μm \times 5.86 μm	69 μm
Alvium G1-240m/c	3.45 μm \times 3.45 μm	24 μm
Alvium G1-319m/c	3.45 μm \times 3.45 μm	24 μm
Alvium G1-500m/c	2.2 μm \times 2.2 μm	15 μm
Alvium G1-507m/c	3.45 μm \times 3.45 μm	24 μm
Alvium G1-510m/c	2.74 μm \times 2.74 μm	tbd
Alvium G1-811m/c	2.74 μm \times 2.74 μm	18 μm
Alvium G1-1236m/c	3.45 μm \times 3.45 μm	24 μm
Alvium G1-1242m/c	2.74 μm \times 2.74 μm	18 μm
Alvium G1-1620m/c	2.74 μm \times 2.74 μm	18 μm
Alvium G1-2040m/c	2.74 μm \times 2.74 μm	18 μm
Alvium G1-2050m/c	2.4 μm \times 2.4 μm	12 μm
Alvium G1-2460m/c	2.74 μm \times 2.74 μm	18 μm

Table 47: Sensor tilt

User sets

Supported features

UserSet features enable to store individual settings on Alvium G1 cameras. These user sets can be loaded by default, without needing to set values by software after every restart of the camera. Or they can be used to switch between different settings, for example, to adjust from daylight to artificial light.

User sets on Alvium G1 cameras support all features except for:

- Selectors
- Command features
- Read-only features
- Features in the LUTControl category.

Trigger features and UserSetDefault

Trigger features are reset to default values when the default user set is loaded.

- Column **UserSetLoad** displays how user values are affected when the command for **UserSetLoad** is executed.
- Column **DeviceReset** displays how user values are affected when the command for **DeviceReset** is executed.

Feature	Default value	UserSetDefault	DeviceReset
TriggerActivation	<i>RisingEdge</i>	Default value	Default value
TriggerMode	<i>Off</i>	Default value	Default value
TriggerSelector	<i>AcquisitionStart</i>	User value	Default value
TriggerSoftware	[Command]	Not applicable	Not applicable
TriggerSource	<i>Software</i>	Default value	Default value

Table 48: Trigger features being reset

Camera feature availability

Alvium G1 cameras support a number of standard and extended features. The following tables compare the availability of selected features by model.



Feature descriptions and firmware downloads

Alvium Features Reference: www.alliedvision.com/en/support/technical-documentation/alvium-gige-documentation

Firmware downloads: www.alliedvision.com/en/support/firmware-downloads.

Image control	Monochrome models	Color models	Exceptions
Adaptive noise filter	✓	✓	N.a.
Auto exposure	✓	✓	N.a.
Auto gain	✓	✓	N.a.
Auto white balance	-	✓	N.a.
Color transformation (including hue, saturation)	-	✓	N.a.
Contrast	✓	✓	N.a.
Custom convolution	✓	✓	N.a.
De-Bayering up to 5x5	-	✓	N.a.
DPC (defect pixel correction)	✓	✓	N.a.
Digital binning	✓	✓	N.a.
FPNC (fixed pattern noise correction)	✓	✓	G1-2050
Gamma	✓	✓	N.a.
Look up table (LUT)	✓	✓	N.a.
Reverse X/Y	✓	✓	N.a.
ROI (region of interest)	✓	✓	N.a.
Sharpness/Blur	✓	✓	N.a.

Table 49: Image control features by Alvium G1 model

Camera control	Monochrome models	Color models	Supported models
Acquisition frame rate	✓	✓	All
Action commands	✓	✓	All
Bandwidth control (<code>DeviceLinkThroughputLimit</code>)	✓	✓	All
Counters and timers	✓	✓	All
Image chunk data	✓	✓	All
I/O and trigger control	✓	✓	All
Firmware update in the field	✓	✓	All
Readout modes (<code>SensorBitDepth</code>)	✓	✓	G1-040, G1-158, G1-240
Serial I/Os	✓	✓	All
Temperature monitoring (mainboard, companion board, interface board)	✓	✓	All
User sets	✓	✓	All

Table 50: Camera control features by Alvium G1 model

Lenses: Focal length vs. field of view

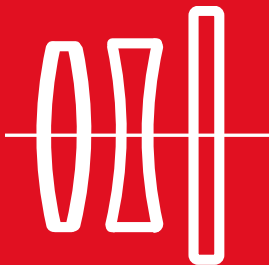

This chapter includes:

About this chapter	103
Optical vignetting with certain lenses	103
About S-Mount lenses	104
Focal length versus field of view	104

About this chapter

This section presents tables that list selected fields of view (FOV) depending on sensor size, distance, and focal length of the lens.

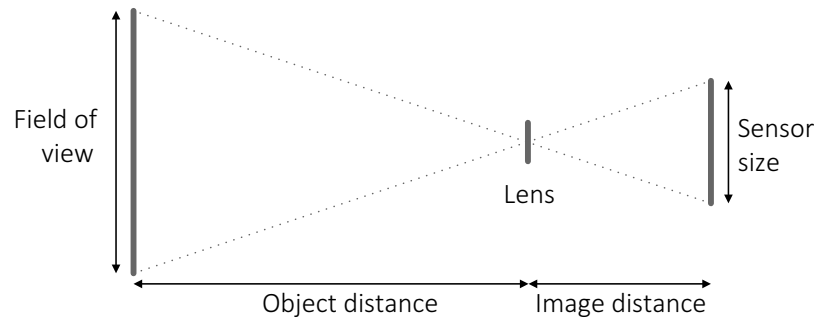

Figure 40: Parameters used in tables for focal length versus FOV



Allied Vision S-Mount lenses

For technical data of Allied Vision S-Mount lenses with dedicated operating instructions, see the S-Mount Lenses User Guide at

www.alliedvision.com/fileadmin/content/documents/products/accessories/lenses/Allied_Vision/User_Guide/S-Mount-Lenses_User-Guide.pdf.

Parameters in tables

The distance to the object is measured from the first principal the plane of the lens to the object. For some lenses, manufacturers do not define the principal plane position. Production spread causes tolerances for all values, including actual focal lengths. Calculations apply for image reproduction without distortion. Therefore, values do not apply for fisheye lenses.

Please ask your Allied Vision Sales representative in case you need more information.

Optical vignetting with certain lenses

Lenses with short focal lengths may show optical vignetting at the edges of the image. Microlenses on the sensor pixels can increase the effect.

For demanding applications, we suggest testing camera and lens to find a suitable setup. If you have questions, please contact your Allied Vision Sales representative.

About S-Mount lenses

Alvium G1 S-Mount models have no filter. We recommend using S-Mount lenses with an integrated IR-cut filter for a better image quality.

Read [Mounting and focusing S-Mount lenses](#) on page 117 to avoid damage when using S-Mount lenses.

Focal length versus field of view

Alvium G1-040m/c

Values for G1-040m/c cameras with Type 1/2.9 (6.3 mm diagonal) sensors:

Focal length [mm]	Field of view (H × V [mm])	
	Object distance = 500 mm	Object distance = 1000 mm
2.8	892 × 667	1789 × 1337
3.6	693 × 518	1390 × 1039
4.8	518 × 387	1041 × 778
6	414 × 309	832 × 622
8	309 × 231	623 × 465
12	204 × 153	414 × 309
16	152 × 114	309 × 231
25	95 × 71	196 × 146

Table 51: Focal length versus field of view for Alvium G1-040m/c

Alvium G1-158m/c

Values for G1-158m/c cameras with Type 1/2.9 (6.3 mm diagonal) sensors:

Focal length [mm]	Field of view (H × V [mm])	
	Object distance = 500 mm	Object distance = 1000 mm
2.8	892 × 667	1789 × 1337
3.6	693 × 518	1390 × 1039
4.8	518 × 387	1041 × 778
6	414 × 309	832 × 622
8	309 × 231	623 × 465
12	204 × 153	414 × 309
16	152 × 114	309 × 231
25	95 × 71	196 × 146

Table 52: Focal length versus field of view for Alvium G1-158m/c

Alvium G1-234m/c

Values for G1-234m/c cameras with Type 1/1.2 (13.4 mm diagonal) sensors:

Focal length [mm]	Field of view (H × V in [mm])	
	Object distance = 500 mm	Object distance = 1000 mm
12 mm	461 × 290 mm	933 × 586 mm
16 mm	343 × 215 mm	697 × 438 mm
25 mm	215 × 135 mm	442 × 278 mm
35 mm	150 × 94 mm	312 × 196 mm
50 mm	102 × 64 mm	215 × 135 mm

Table 53: Focal length versus field of view for Alvium G1-234m/c

Alvium G1-240m/c

Values for G1-240m/c cameras with Type 1/2.3 (7.9 mm diagonal) sensors:

Focal length [mm]	Field of view (H × V in [mm])	
	Object distance = 500 mm	Object distance = 1000 mm
4.8	691 × 433	1389 × 871
6	552 × 346	1110 × 696
8	412 × 258	831 × 521
12	272 × 171	552 × 346
16	203 × 127	412 × 258
25	127 × 80	261 × 164
35	89 × 56	185 × 116
50	60 × 38	127 × 80

Table 54: Focal length versus field of view for Alvium G1-240m/c

Alvium G1-319m/c

Values for G1-319m/c cameras with Type 1/1.8 (8.9 mm diagonal) sensors:

Focal length [mm]	Field of view (H × V in [mm])	
	Object distance = 500 mm	Object distance = 1000 mm
4.8	735 × 550	1476 × 1104
6	586 × 439	1180 × 882
8	438 × 328	883 × 661
12	290 × 217	586 × 439
16	215 × 161	438 × 328
25	135 × 101	278 × 208
35	95 × 71	196 × 147
50	64 × 48	135 × 101

Table 55: Focal length versus field of view for Alvium G1-319m/c

Alvium G1-500m/c

Values for G1-500m/c cameras with Type 1/2.5 (7.1 mm diagonal) sensors:

Focal length [mm]	Field of view (H × V in [mm])	
	Object distance = 500 mm	Object distance = 1000 mm
2.8	1013 × 759	2031 × 1523
3.6	786 × 590	1578 × 1184
4.8	588 × 441	1182 × 887
6	469 × 352	945 × 709
8	351 × 263	707 × 530
12	232 × 174	469 × 352
16	172 × 129	351 × 263
25	108 × 81	222 × 167

Table 56: Focal length versus field of view for Alvium G1-500m/c

Alvium G1-507m/c

Values for G1-507m/c cameras Type 2/3 (11.1 mm diagonal) sensors:

Focal length [mm]	Field of view (H × V in [mm])	
	Object distance = 500 mm	Object distance = 1000 mm
6	700 × 584	1408 × 1175
8	523 × 436	1054 × 880
12	346 × 288	700 × 584
16	257 × 215	523 × 436
25	162 × 135	332 × 277
35	113 × 94	234 × 196
50	77 × 64	162 × 135

Table 57: Focal length versus field of view for Alvium G1-507m/c

Alvium G1-510m/c

Values for G1-510m/c cameras with Type 1/1.8 (8.8 mm diagonal) sensors:

Focal length [mm]	Field of view (H × V in [mm])	
	Object distance = 500 mm	Object distance = 1000 mm
5	671 × 560	1348 × 1125
6	558 × 466	1122 × 937
8	417 × 348	840 × 701
12	275 × 230	558 × 466
16	205 × 171	417 × 348
25	129 × 107	264 × 221
35	90 × 75	187 × 156
50	61 × 51	129 × 107

Table 58: Focal length versus field of view for Alvium G1-510m/c

Alvium G1-811m/c

Values for G1-811m/c cameras Type 2/3 (11 mm diagonal) sensors:

Focal length [mm]	Field of view (H × V in [mm])	
	Object distance = 500 mm	Object distance = 1000 mm
5	773 × 773	1553 × 1553
6	642 × 642	1293 × 1293
8	480 × 480	968 × 968
12	317 × 317	642 × 642
16	236 × 236	480 × 480
25	148 × 148	304 × 304
35	104 × 104	215 × 215
50	70 × 70	148 × 148

Table 59: Focal length versus field of view for Alvium G1-811m/c

Alvium G1-1236m/c

Values for G1-1236m/c cameras with Type 1.1 (17.6 mm diagonal) sensors:

Focal length [mm]	Field of view (H × V in [mm])	
	Object distance = 500 mm	Object distance = 1000 mm
8	872 × 638	1759 × 1287
12	577 × 422	1168 × 854
16	429 × 314	872 × 638
25	270 × 197	553 × 405
35	188 × 138	391 × 286
50	128 × 93	270 × 197
75	80 × 59	175 × 128

Table 60: Focal length versus field of view for Alvium G1-1236m/c

Alvium G1-1242m/c

Values for G1-1242m/c cameras with Type 1/1.1 (14 mm diagonal) sensors:

Focal length [mm]	Field of view (H × V in [mm])	
	Object distance = 500 mm	Object distance = 1000 mm
6	931 × 679	1874 × 1365
8	696 × 507	1403 × 1022
12	460 × 335	931 × 679
16	342 × 249	696 × 507
25	215 × 157	441 × 321
35	150 × 109	312 × 227
50	102 × 74	215 × 157
75	64 × 47	139 × 102

Table 61: Focal length versus field of view for Alvium G1-1242m/c

Alvium G1-1620m/c

Values for G1-1620m/c cameras with Type 1.1 (16.8mm diagonal) sensors:

Focal length [mm]	Field of view (H × V in [mm])	
	Object distance = 500 mm	Object distance = 1000 mm
5	1445 × 825	2905 × 1658
6	1202 × 686	2419 × 1380
8	898 × 512	1810 × 1033
12	594 × 339	1202 × 686
16	442 × 252	898 × 512
25	277 × 158	569 × 325
35	194 × 111	403 × 230
50	131 × 75	277 × 158
75	83 × 47	180 × 103

Table 62: Focal length versus field of view for Alvium G1-1620m/c

Alvium G1-2040m/c

Values for G1-2040m/c cameras with Type 1.1 (17.5 mm diagonal) sensors:

Focal length [mm]	Field of view (H × V in [mm])	
	Object distance = 500 mm	Object distance = 1000 mm
6	1018 × 1018	2048 × 2048
8	760 × 760	1533 × 1533
12	503 × 503	1018 × 1018
16	374 × 374	760 × 760
25	235 × 235	482 × 482
35	164 × 164	341 × 341
50	111 × 111	235 × 235
75	70 × 70	152 × 152
85	60 × 60	133 × 133

Table 63: Focal length versus field of view for Alvium G1-2040m/c

Alvium G1-2050m/c

Values for G1-2050m/c cameras with Type 1 (15.86 mm diagonal) sensors:

Focal length [mm]	Field of view (H × V in [mm])	
	Object distance = 500 mm	Object distance = 1000 mm
8	811 × 542	1636 × 1093
12	536 × 358	1086 × 726
16	399 × 267	811 × 542
25	251 × 167	514 × 344
35	175 × 117	364 × 243
50	119 × 79	251 × 167
75	75 × 50	163 × 109
85	64 × 43	142 × 95
100	53 × 35	119 × 79

Table 64: Focal length versus field of view for Alvium G1-2050m/c

Alvium G1-2460m/c

Values for G1-2460m/c cameras with Type 1.2 (19.3 mm diagonal) sensors:

Focal length [mm]	Field of view (H × V in [mm])	
	Object distance = 500 mm	Object distance = 1000 mm
8	898 × 776	1810 × 1566
12	594 × 513	1202 × 1040
16	442 × 382	898 × 776
25	277 × 240	569 × 492
35	194 × 168	403 × 348
50	131 × 114	277 × 240
75	83 × 72	180 × 156

Table 65: Focal length versus field of view for Alvium G1-2460m/c

Installing the camera



This chapter includes:

Touching hot cameras	113
Usage of heat sinks	113
Mounting the camera	114
Mounting the lens.....	116
Configuring the host computer	120
Connecting to the host computer	123
Powering up the camera.....	124

Touching hot cameras



CAUTION

Risk of burns

A camera in operation can reach temperature levels which could cause burns.

- Wear protective gloves when you touch a camera that is heated up.
- Ensure proper cooling of the camera.

Keep the operating temperature in the specified range to enable best image quality and to protect the camera from damage. In many cases, mounting the camera on a metal surface or using a lens will be sufficient to cool the camera effectively. However, especially when operated in higher ambient temperatures, additional measures for heat dissipation, such as using a heat sink, should be considered.

Usage of heat sinks

Alvium G1 cameras can be operated without heat sinks in most applications. However, heat sinks can be used to reduce image noise and power consumption.



Automatic power off

If the mainboard temperature exceeds the specified maximum for more than two seconds, the camera is powered off automatically. Afterwards, you must power cycle the camera for restart. The current value for mainboard temperature is output by `DeviceTemperature`.



NOTICE

Damage to the camera by heat sinks mounted improperly

Adhere to the instructions and safety notes provided by the manufacturer of the heat sink.



NOTICE

Damage to the sensor, filter, and lens by corrosive substances

Some conductive media for heat sinks contain corrosive substances that can damage optical surfaces of the sensor, filter, and lens.

- Cover the optical path of the camera when you apply heat sink compound or adhesive to prevent substances and fumes from damaging optical surfaces.
- Adhere to the instructions and safety notes provided by the manufacturer of the conductive media.

Mounting the camera



CAUTION

Injury by falling cameras or lenses

A falling camera or lens can cause injury.

- Ensure proper mounting of cameras and lenses, especially for dynamic applications.
- Mount cameras as described in the instructions.
- Always make sure the mounting threads are intact.
- Fasten screws with maximum torque, using the entire thread engagement. For less thread engagement, see [Adapting maximum torque values](#) on page 115.
- We recommend you to apply thread locking.
- Use a lens support for heavy lenses.

Bottom or top mounting

Especially for dynamic applications with high acceleration, mount the camera using the bottom mounting threads in addition.

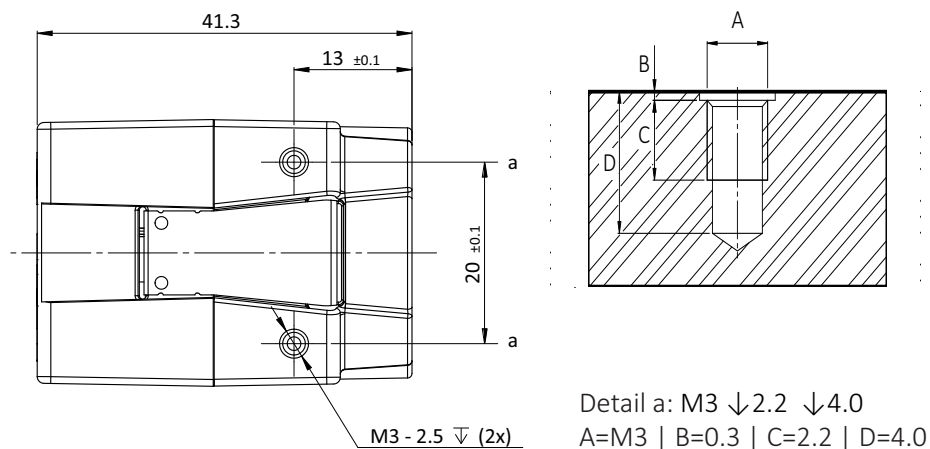

Figure 41: Mounting threads bottom and top (a)

The maximum torque value applies only if the entire thread engagement is used. For other values, see [Adapting maximum torque values](#) on page 115. For technical drawings, see [Dimensions and mass](#) on page 92.

1. As shown in [Figure 41](#), mount the camera to the base using suitable M3 screws for mounting thread a: At 0.51 Nm maximum torque for a thread engagement (C) of 2.2 mm between screws and mounting threads.
2. Continue with [Mounting the lens](#) on page 116.

Front mounting

Especially for dynamic applications with high acceleration, mount the camera using the bottom mounting threads in addition.

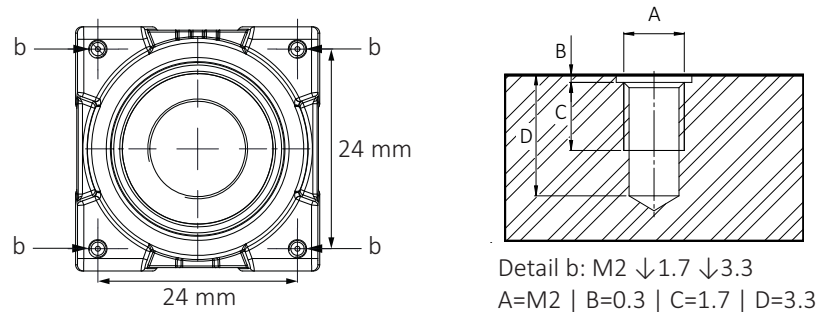

Figure 42: Camera front with mounting threads (c)

The maximum torque value applies only if the entire thread engagement is used. For other values, see [Adapting maximum torque values](#) on page 115.

1. Mount the camera to the base using suitable M2 screws at 0.17 Nm maximum torque for a thread engagement (C) of 1.7 mm between screws and mounting threads, see [Figure 42](#). For technical drawings, see [Dimensions and mass](#) on page 92.
We recommend you to additionally use bottom and top mounting threads for a more solid connection.
2. Continue with [Mounting the lens](#) on page 116.

Adapting maximum torque values

The total bolt length composes of the mounting holes length and the height of your mounting base.

For using less than the stated length of thread engagement, calculate maximum torque as follows:

$$\frac{\text{Current length of thread engagement}}{\text{Length of thread engagement in table}} \times \text{Torque in table} = \text{Current torque}$$

Example for a length of thread engagement of **1.4 mm** instead of 1.7 mm:

$$\mathbf{1.4 \text{ mm} / 1.7 \text{ mm} \times 0.17 \text{ Nm} = \mathbf{0.14 \text{ Nm}}$$

Thread group	Thread position	Thread type	Total protrusion	Length of thread engagement	Maximum torque
b	Front mounting	M2	2 mm	1.7 mm	0.17 Nm
b	Front mounting	M2	2 mm	1.4 mm	0.14 Nm

Table 66: Adjusting maximum torque values

To ensure that the bolts do not become loose over time, we recommend you to use means for securing bolts, such as screw locking varnish.

**Tripod adapter**

For the G1 tripod adapter, see www.alliedvision.com/en/support/accessory-documentation.

Mounting the lens

Observe the following notes before you mount lenses to Alvium G1 cameras.

**CAUTION****Injury by falling cameras or lenses**

A falling camera or lens can cause injury.

- Ensure proper mounting of cameras and lenses, especially for dynamic applications.
- Mount cameras as described in the instructions.
- Use a lens support for heavy lenses.

**CAUTION****Risk of cuts by sharp edges of lens mounts**

The threads of the lens mount can have sharp edges.

Be careful when mounting or unmounting lenses.

**NOTICE****Damage to sensor or optics by unsuitable lenses**

The sensor, filter, or lens can be damaged if a lens exceeding maximum protrusion is mounted to the camera.

- Use lenses only up to the specified maximum protrusion.
- S-Mount lenses must be screwed into the camera less than maximum protrusion (11.0 mm).
- Avoid short S-Mount lenses falling into the camera.

Mounting and focusing S-Mount lenses



Allied Vision S-Mount lenses

For technical data of Allied Vision S-Mount lenses with dedicated operating instructions, see the S-Mount Lenses User Guide at www.alliedvision.com/fileadmin/content/documents/products/accessories/lenses/Allied_Vision/User_Guide/S-Mount-Lenses_User-Guide.pdf.

This section instructs how to use S-Mount lenses with your camera safely. S-Mount lenses are screwed into the mount to adjust focus. Vibration moves lenses out of position. Several techniques can be used to fasten S-Mount lenses in focus. We recommend using fixing nuts. See instructions in this section.



Drawings of cameras and fixing nuts

Drawings in the instructions are schematic.

Several manufacturers offer various types of S-Mount fixing nuts. The type shown in the instructions drawings is an example.

We recommend using pinch nose pliers to tighten fixing nuts.

Figure 43 shows how fixing nuts lock S-Mount lenses.
Follow the instructions to lock the lens in focus position.

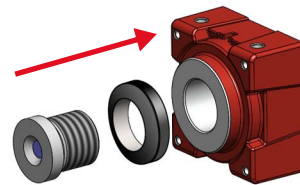

Figure 43: Fixing nut locking an S-Mount lens

NOTICE
Damage to sensor or optics by improper handling

If an S-Mount lens is screwed against the sensor, sensor and lens can be damaged.

- Screw in the lens at 11.0 mm maximum protrusion.
- Follow the instructions carefully.

Determining the allowed range for the position of the lens

1. Measure the length of the lens.
2. Calculate: $a = c - b$
 a: length of the mounted lens, measured from lens mount front flange
 b: maximum protrusion (11.0 mm)
 c: length of the lens

See [Lens mounts and maximum protrusion](#) on page 95.

3. Set a gauge to the length of (a).

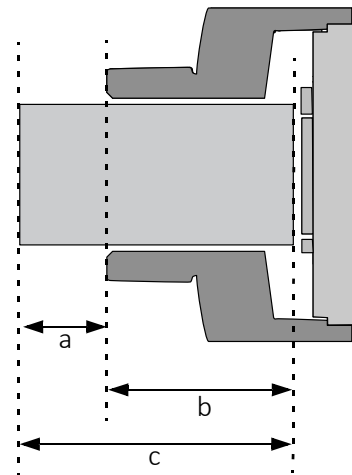

Figure 44: S-Mount lens and maximum protrusion

Mounting the fixing nut to the lens

4. Screw the fixing nut clockwise onto the lens until you can hold the front part (d) of the lens with your finger tips.

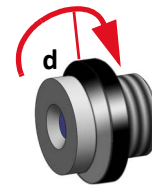

Figure 45: Lens and fixing nut

Focusing the lens

5. **Checking (a) with a gauge**, slowly screw the lens clockwise into the lens mount until the image is roughly in focus.
6. Slowly screw the lens in and out until you have found most accurate focus.

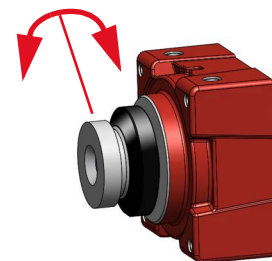

Figure 46: Adjusting focus

NOTICE
Damage to lens threads and fixing nut by excessive force

If the fixing nut is screwed with too much force, threads are worn out and the lens cannot be locked anymore.

Screw fixing nuts hand tight to keep the lens in a fixed position.

Locking focus

Pinch nose pliers are used to screw the fixing nut:

7. Holding the lens in position with one hand, screw the fixing nut clockwise against the lens mount until you feel the lens is locked.

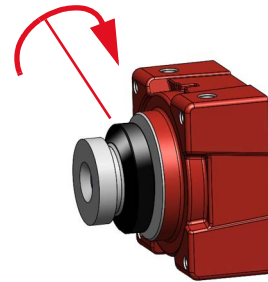

Figure 47: Tightening the fixing nut

Checking focus is set and locked properly

8. Check No.1: Try to rotate the lens with little strength in both directions to ensure the lens is safely locked in position.

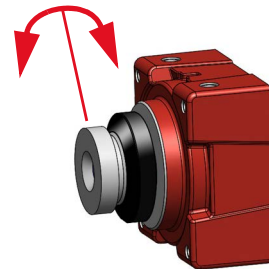

Figure 48: Checking lens is safely locked

9. Check No. 2: S-Mount thread allows a slightly tilted lens position. In this case, focus for a common object plane varies over the image plane.

If focus is constant over the image plane, you are done.

If focus varies over the image plane, the lens is tilted. Continue with [10](#).

10. Loosen the fixing nut.

11. Continue with [6](#).

The lens is locked in focus and ready for operation.

Configuring the host computer



Please consider...

Alvium G1 cameras require different hardware and settings than 1000BASE-T cameras like Mako or Prosilica GT cameras. We suggest you:

- Build up general knowledge: on page 142.
- Find solutions for issues: [Troubleshooting common issues](#) on page 157.

Alvium G1 cameras can operate on 100 and 1000BASE-T NICs. Requirements to reach the maximum camera frame rate:

- 1000BASE-T speed PCI Express NIC **on Desktop PCs**
- Jumbo Packet support for minimum 9,000 bytes. See [Enabling Jumbo Packets](#) on page 122.

Recommendations:

- Use only one camera per network port. For than one camera, use additional NICs or NICs with more than one port.
- Disable all unused NIC services and protocols (for example, activate only filter drivers for IPv4 and GigE).
- You can select between Fixed Link Speed and Auto Negotiation for the NIC driver's link speed settings.
 - **Fixed Link Speed:** If you set a link speed not supported by the camera, the link is not negotiated. Alvium G1 cameras support 1 Gbit/s for full performance or 100 Mbit/s for host systems that do not support 1 Gbit/s.
 - **Auto Negotiation:** We recommend using Auto Negotiation. The maximum link speed supported by the host system and the camera is set automatically. Therefore, the common link speed for the camera and host system may be lower than the maximum supported link speed of one of the two.



NOTICE

Network security

If cameras are used on mixed-use networks (with printers, Internet, and email), the network security may be affected, the camera performance as well.

- Use cameras only in trusted networks as required by the GigE Vision protocol.
- Check with your network administrator if required for network configuration.

Installing the NIC driver

Install the NIC driver from your network card manufacturer if available. If no installation application is provided, update the driver manually.

Linux: Updating the driver manually

Follow the instructions by the NIC manufacturer.

Windows: Updating the driver manually

1. Open the **Device Manager** with administrator permission.
2. Under **Network Adapters**, locate the Ethernet network adapter, right-click the entry, and select **Update Driver Software** in the menu.
3. Select the **Search automatically for updated driver software** or **Browse my computer for driver software**.
4. Click **Close** after the driver has been installed.

Modifying the NIC IP address

This step is optional.

After the initial NIC hardware installation, connect the NIC directly to the camera. The default configuration assigns an IP address automatically using the Link-Local Address range of 169.254.xxx.xxx or an address defined by the DHCP server, if present.

Users can fix the NIC address to minimize the time required for a camera to be recognized by the host application.

To connect to the camera, edit the host computer's adapter settings and configure the following settings:

- IP Address: 169.254.100.1
- Subnet mask: 255.255.0.0
- Default gateway: blank

When systems employ multiple NICs connected to multiple cameras the address of the NICs should be set. Each NIC or NIC card port requires a unique IP address.

For example:

NIC 1:

- IP Address: 169.254.100.1
- Subnet mask: 255.255.0.0
- Default gateway: blank

NIC 2:

- IP Address: 169.254.100.2
- Subnet mask: 255.255.0.0
- Default gateway: blank

Adjusting the NIC driver settings

The NIC should be adjusted to improve system performance when using Alvium G1 cameras. This is achieved by minimizing the CPU usage in order to avoid dropped or resent packets.

Edit the NIC driver properties according to the values in the following table. The names and availability of the properties listed may vary depending on

- NIC manufacturer
- Operating system
- Camera model.

Property	Value
Packet Size, Frame Size, Jumbo Packet, or Maximum Transmission Unit	Maximum value configurable
Interrupt moderation	Enable
Interrupt moderation rate	Start with NIC's default value and experiment with different setting if required
Receive buffers	Maximum value configurable

Table 67: NIC settings

Default packet size

At startup, Alvium G1 cameras have a default packet size of 576 bytes on the device stream channel. This enables optimum backward compatibility when ancient network hardware is used or when the network packets are tunneled through other protocols. Consider, that this packet size creates a large overhead on the host, which does not allow the full throughput most likely.

Enabling Jumbo Packets

We recommend you to increase the packet size to the maximum value supported by all parts of the system. The effective packet size should be at least around **9,000 bytes**. Configure the NIC settings as follows:

1. Open the **Device Manager** with administrator permission.
2. Under **Network Adapters**, locate the Ethernet network adapter, right-click the entry, and select **Properties** in the menu.
3. Adjust the corresponding settings to match the values required in [Table 67](#).



Easy adjustment of the packet size

We recommend using **Vimba** to adjust the packet size on connected cameras. See the Vimba C Manual that is included in the download of **Vimba Suite** at www.alliedvision.com/en/support/software-downloads

Connecting to the host computer

Use a Category 6 or higher rated Ethernet cable to connect the Alvium G1 camera to the NIC. Crossover cabling is not required but does work. The camera has circuitry to determine if a crossover cable is being used.



We recommend Category 6 (CAT6) or higher rated Ethernet cables for Alvium G1 cameras. A different rating may not sustain peak interface bandwidth; leading to lost connectivity or dropped frames coming from the camera.

After you have installed the **Vimba Suite**, including **Vimba Viewer** or third-party application to your host computer, connect your Alvium G1 camera via an Ethernet cable. If your camera is not PoE powered, connect the TFM I/O cable to power the camera.

Allied Vision software

Software packages provided by Allied Vision are free of charge and contain such as:

- Drivers
- SDK for camera control and image acquisition
- Examples based on the provided APIs of the SDK
- Documentation and release notes
- Viewer application to operate and configure the cameras



Download **Vimba Suite** from www.alliedvision.com/en/products/software. After installing, documentation is located in the **Vimba** program folder.

Third-party software

In addition to the software provided by Allied Vision, there are numerous GigE Vision standard compliant third-party software options available. In general, third-party software provides increased functionality such as image processing and video recording.

Allied Vision's **Vimba Suite** is based on the GenICam standard. GenICam-based third-party software automatically connects with Vimba's transport layers. Additionally, Vimba includes the Cognex Adapter for VisionPro.

Powering up the camera

Powering the camera via I/O port

When cameras are powered by both the 10-pin TFM I/O port and by PoE, power by the I/O port is used.



NOTICE

Damage to the camera electronics

- Use only DC power supplies that comply with the camera specifications and that have insulated cases.
- When using external power supplies, pay attention to the alignment marks on the 10-pin TFM connector and socket. Inserting the plug in the wrong orientation might cause damage to the camera electronics and peripherals.
- For all cable connections, use only shielded cables to avoid electromagnetic interference.



External power supply

For the 13870 10-pin TFM power supply, see www.alliedvision.com/en/support/accessory-documentation.

Powering the camera via PoE

Please note the following when using PoE NICs and PoE injectors with Allied Vision PoE-capable Alvium G1 cameras:

Feature	Specification
Supported standard	IEEE 802.3af, Power Class 0
Cable category	We recommend you to use Category 6 cables for better performance.
PSE	Power Sourcing Equipment (PSE) must support data over all 4 pairs and must be rated for the intended link speed.

Table 68: Powering the camera via PoE

Camera interfaces

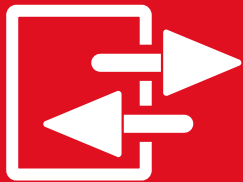

This chapter includes:

I/Os: Precautions	126
Back panel	127
I/O connector pin assignment	128
I/Os and GPIOs	129
Status LEDs	134

I/Os: Precautions



NOTICE

Damage to the camera or connected peripherals

The PoE implementation is non-isolated.

Therefore, when the camera is powered by PoE:

- Only connect the pins 3, 4, 5, 6 and 10 (isolated I/Os).
- **Do not** connect any other pins of the TFM connector.



NOTICE

Damage by reverse polarity

If Alvium G1 cameras are externally powered with reverse polarity, the cameras can be damaged.

Power Alvium G1 cameras according to the specifications described in this chapter.



NOTICE

Damage by serial communication voltage levels

If you are using serial communication (UART, similar to RS232), keep voltage levels in the range defined in [Table 70](#) on page 128. Typical RS232 voltage levels (such as ± 10 VDC) are not supported without external circuitry.



I/O cables maximum length

The maximum length for I/O cables must not exceed 30 m.



Signal level

Consider this when you connect external devices to your camera, for example, to trigger lighting:

- The default signal level for isolated GPO2 is low at camera startup.
- The default signal level for non-isolated GPIO0 and GPIO1 is high at camera startup.

Use the `LineConverter` feature to configure I/Os and GPIOs for your needs.

Back panel

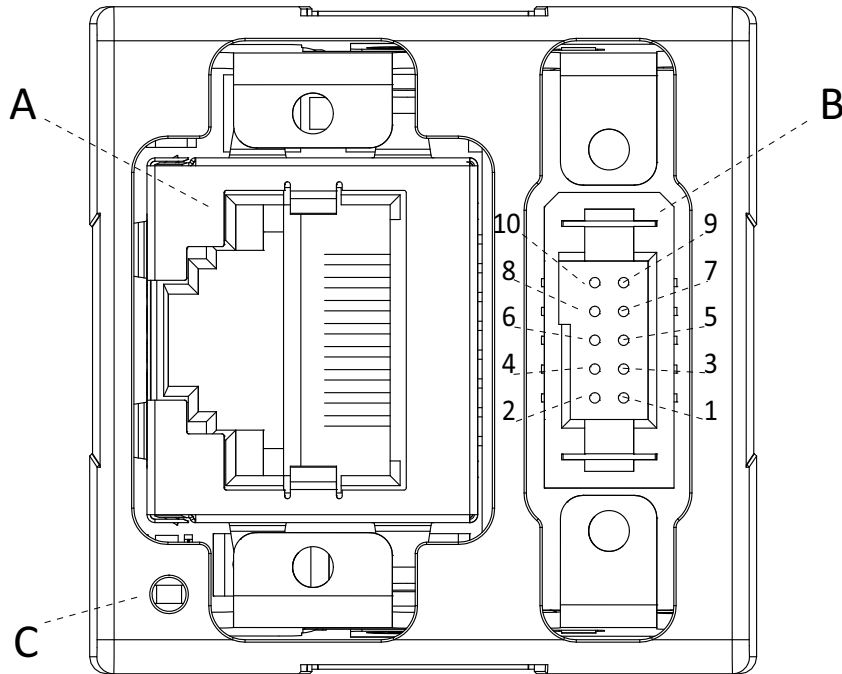

Figure 49: Back panel of camera

	Description
A	Ethernet port
B	I/O connector
C	LED

Table 69: Ports and LED



I/O connector

The I/O connector is 10-pin TFM connector type is an TFM-105-02-L-D-WT-K-TR.

We recommend using cables by Allied Vision. If you are going to manufacture your own cables, see SFSD, ISDF, or SFM series at www.samtec.com.



I/O cables

For I/O cables at different lengths with 10 Pin TFM to open ends, see www.alliedvision.com/en/support/accessory-documentation.

I/O connector pin assignment

The general purpose I/O port uses a 10-pin TFM connector on the camera side.

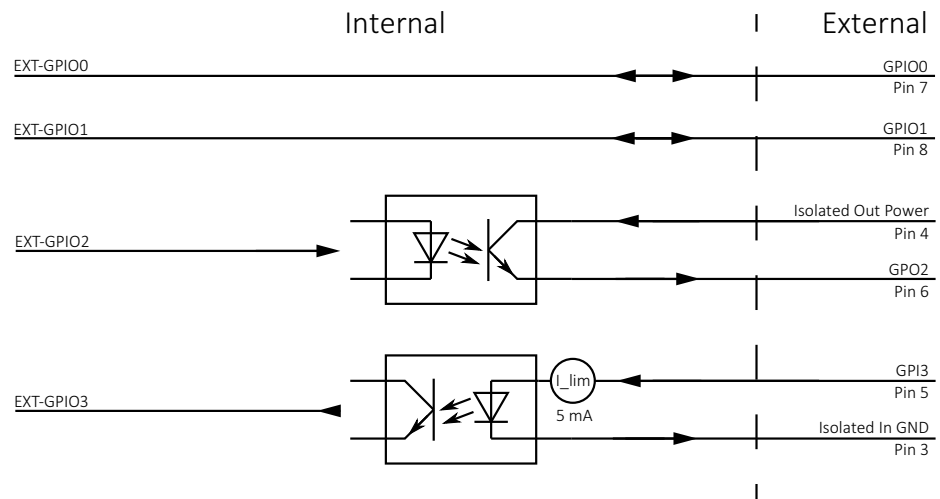

Figure 50: TFM I/O connector pin assignment

Pin	Signal	Direction	Level	Description
1	PWR-GND	In	0 VDC	Supply Ground
2	PWR-IN	In	10.8 to 26.4 VDC	Power supply voltage
3	OPTO-IN-GND	In	0 VDC	Isolated input ground
4	OPTO-OUT-PWR	In	max. 30 VDC	Power for isolated output
5	GPI3	In	$U_{in}(\text{high}) = 3.0 \text{ to } 24.0 \text{ V up to } 36 \text{ VDC}$ with $3.3 \text{ k}\Omega$ ext. resistor in series $U_{in}(\text{low}) = 0 \text{ to } 1.0 \text{ V}$	Isolated Input
6	GPO2	Out	Open emitter, max. 20 mA	Isolated Output
7	GPIO0	In/Out	$U_{in}(\text{low}) = -0.3 \text{ to } 0.8 \text{ VDC}$ $U_{in}(\text{high}) = 2.0 \text{ to } 5.5 \text{ VDC}$ $U_{out}(\text{low}) = 0 \text{ to } 0.4 \text{ VDC}$ $U_{out}(\text{high}) = 2.4 \text{ to } 3.3 \text{ VDC at max. } 20 \text{ mA}$	Non-isolated I/O (LVTTTL)
8	GPIO1		See Pin 7, GPIO0	
9			Reserved	
10	C-GND	PWR	0 VDC	Chassis ground and shielding

Table 70: TFM I/O connector pin assignment

I/O use for UART

Table 71 shows which values must be selected to control I/Os using LineSelector.

Signal	LineSelector (GenICam)	UART line
EXT-GPIO 0	Line0	Not applicable
EXT-GPIO 1	Line1	Not applicable
EXT-GPIO 2	Line2	UART Tx
EXT-GPIO 3	Line3	UART Rx

Table 71: Value settings to control I/Os using the LineSelector feature



Feature descriptions and firmware downloads

Alvium Features Reference: www.alliedvision.com/en/support/technical-documentation/alvium-gige-documentation

Firmware downloads: www.alliedvision.com/en/support/firmware-downloads.

I/Os and GPIOs

Isolated input description

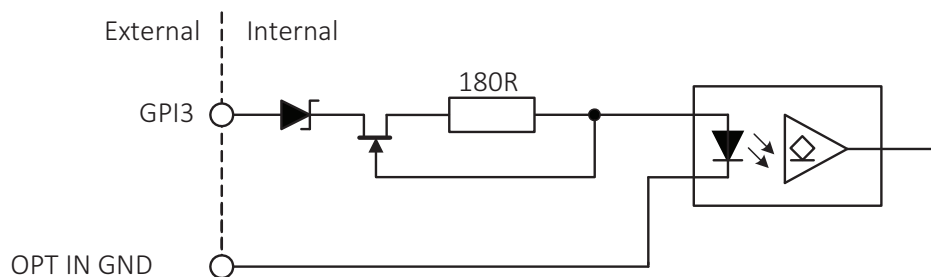

Figure 51: Input block diagram

The input can be connected directly to the system for voltages up to 24 VDC. An external resistor is not necessary.

Levels

Parameter	Value
U_{in} (low)	0 to 1.0 V
U_{in} (high)	3 to 24 V
Current (constant-current source)	3 to 4 mA

Table 72: Input parameters

Minimum pulse width

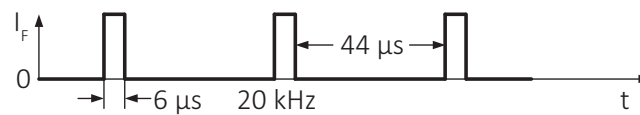

Figure 52: Minimum pulse width

Test conditions

The input signal was driven with 3.3 V and no external additional series resistor.

Isolated output description

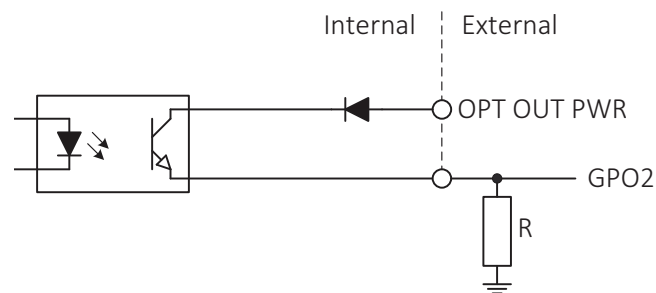

Figure 53: Output block diagram

Levels



NOTICE

Damage to the camera by high output current or voltage

Exceeding the maximum output voltage or current can damage the camera. Keep maximum output voltage below 24 VDC and output current below 20 mA.

Isolated out power	Resistor value ¹	
5 V	1.0 kΩ	at ~ 5 mA minimum required current draw
12 V	2.4 kΩ	
24 V	4.7 kΩ	

¹ A resistor is required when GPO2 is connected to a device with a high impedance < 5 mA draw.

Table 73: Isolated out power and external resistor

Switching times

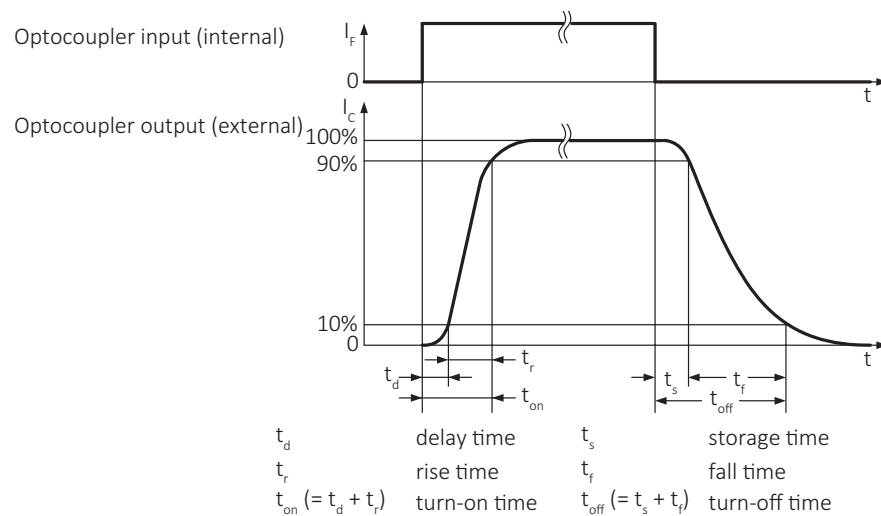

Figure 54: Output switching times

Parameter and value	
$t_d \approx 1 \mu\text{s}$	$t_s \approx 26 \mu\text{s}$
$t_r \approx 1 \mu\text{s}$	$t_f \approx 21 \mu\text{s}$
$t_{on} = t_d + t_r \approx 2 \mu\text{s}$	$t_{off} = t_s + t_f \approx 47 \mu\text{s}$ (t_{off} can deviate by $\pm 5 \mu\text{s}$)

Table 74: Output parameters

Test conditions

Output: external 2.4 kΩ resistor to GND, isolated out power set to 12 V.



Higher external values increase the times in the previous table.

Non-isolated GPIOs description

The camera has two non-isolated GPIOs that can be configured by software to act as inputs or outputs.

Alvium G1 GPIOs use the push-pull technology to switch the signal level between low and high. For low levels, the signal is "pulled" down towards ground level. For high levels, the signal is "pushed" up towards VCC level.

Alvium G1 GPIOs feature the CMOS push-pull output drivers and Schmitt trigger inputs with an internal pull-up resistor and a filter circuit, shown in [Figure 55](#). The push-pull GPIOs are able to source or sink current from an external pin.

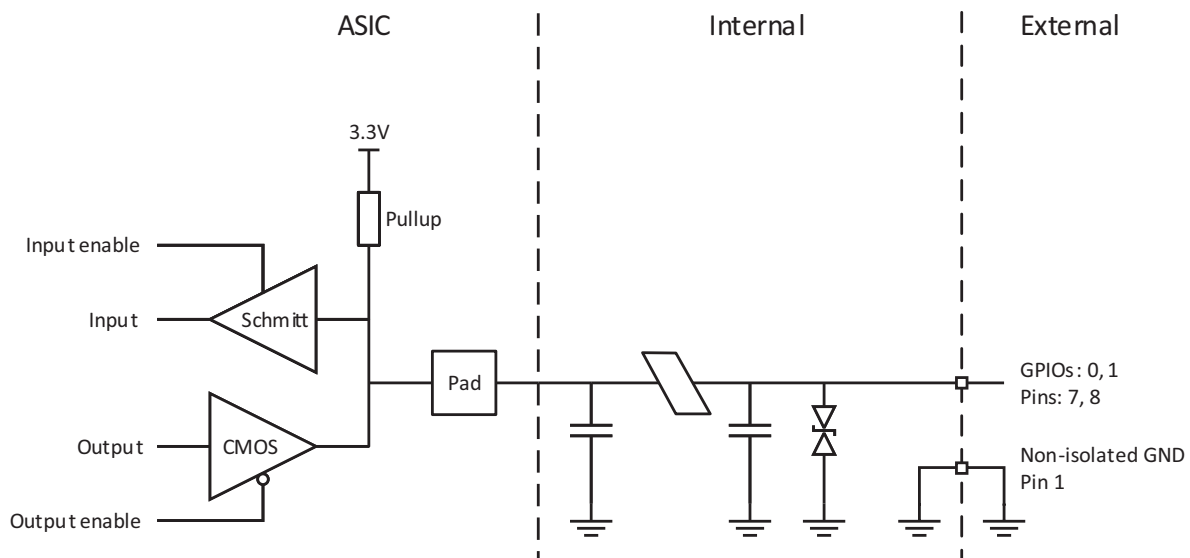

Figure 55: GPIOs block diagram

Input levels

The GPIOs can be connected directly to the system controlling the camera for voltages up to 5.5 VDC. An external resistor is not necessary.



NOTICE

Damage to the camera by high input voltage

Exceeding the maximum input voltage can damage the camera.

Keep maximum input voltage below 5.5 VDC.

Parameter	Value
U_{in} (low)	-0.3 to 0.8 VDC
U_{in} (high)	2.0 to 5.5 VDC
Undefined levels	0.8 to 2.0 VDC

Table 75: GPIOs as input, voltage levels

Output levels



NOTICE

Damage to the camera by high output current

The camera can be damaged when connected to a device that exceeds the specified maximum current or voltage. Keep the maximum current below 12 mA per output.

Parameter	Value
External output voltage U_{out} (low, Off state)	0 to 0.4 VDC
External output voltage U_{out} (high, On state)	2.4 to 3.3 VDC
Undefined levels	0.4 to 2.4 VDC
Maximum external output voltage	3.3 VDC
Maximum output current	12 mA

Table 76: GPIOs as output, current and voltage levels



Output voltage for U_{out} (high) = On state

The voltage level in the On state depends on the load current. Higher currents yield lower voltage.

Status LEDs

Alvium G1 cameras have LEDs to signal in yellow, green, or red color.



LED settings

You can define LED settings with the `DeviceIndicatorLuminance` feature:

- A value of `10` enables LED signaling at the highest luminance level.
- Values below `10` reduce the luminance level.
- `0` disables LED signaling.

LED codes



LED codes	Behavior	Status
	Continuously active	Camera is initializing
	1 flash per second	Camera is operational
	Continuously active	Error state

Table 77: LED codes



Yellow LED color

With yellow, a green and a red LED are active in parallel. Seen directly from behind, this appears as yellow; seen from an angle, you can see green and red separately.

Error state

If the camera signals an error, try the following to get the camera back to normal operation:

- Restart the camera.
- Should this fail, please contact support at www.alliedvision.com/en/about-us/contact-us/technical-support-repair/-rma.

Triggering and timings



This chapter includes:

Trigger signal flow	136
Trigger latency	136
Triggering with rolling shutter cameras	137

Trigger signal flow

Figure 56 shows a general diagram for the trigger signal flow. The external signal can be a physical source, such as light barrier as hardware trigger or a software trigger. This external signal starts the exposure of a frame. The end of exposure starts the readout. High levels show the active state of a signal.



Feature descriptions and firmware downloads

Alvium Features Reference: www.alliedvision.com/en/support/technical-documentation/alvium-gige-documentation

Firmware downloads: www.alliedvision.com/en/support/firmware-downloads.

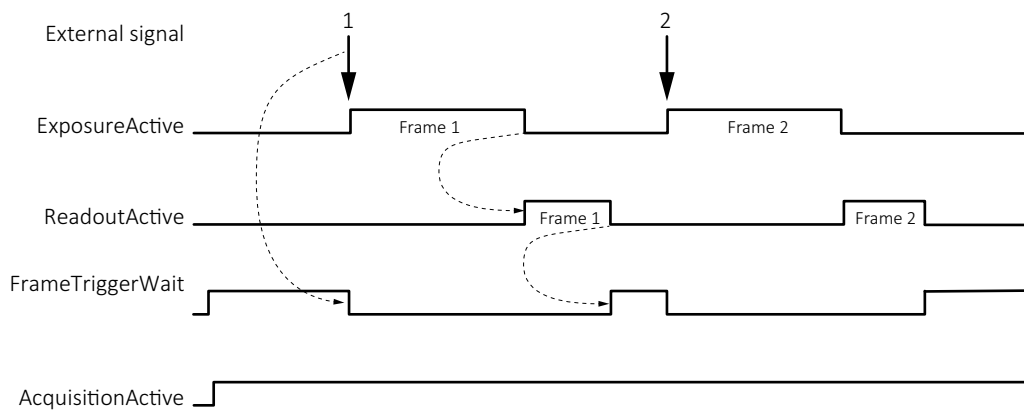

Figure 56: Schematic trigger signal flow

Term	Description
External signal	Electrical trigger signal starting the signal flow
<i>ExposureActive</i>	Exposing a frame
<i>ReadoutActive</i>	Reading out a frame
<i>FrameTriggerWait</i>	Waiting for a trigger
<i>AcquisitionActive</i>	Enables frame acquisition: Expose, read out data, or wait for triggers.

Table 78: Trigger signal flow terms

Trigger latency

In theory, a trigger creates an immediate response of the camera, depending on the cable length. In practice, the computer may add a delay that is mostly unpredictable, especially on Windows systems. In addition, camera electronics and sensors have a delay.

We recommend you to trigger on the rising edge for the fastest reaction time.

Electronic rolling shutter (ERS) cameras in this document also have exposure delay, depending on camera settings, see [Triggering with rolling shutter cameras](#) on page 137. Electronic rolling shutter is commonly called rolling shutter.

Triggering with rolling shutter cameras

This section describes triggering behavior for **Alvium G1-500m/c and G1-2050m/c** cameras with rolling shutter sensor. Figure 57 shows how an external signal triggers exposure and readout for cameras with rolling shutter sensors. Like for global shutter sensors, readout has a constant duration, acquisition must be active to enable exposure, the end of exposure starts readout.

ERS sensors run in cycles where **readout area** equals **exposure area**. Overlapping triggering is not supported. If exposure time is shorter than readout time, exposure starts with a delay:

Exposure start delay = exposure area – exposure time.

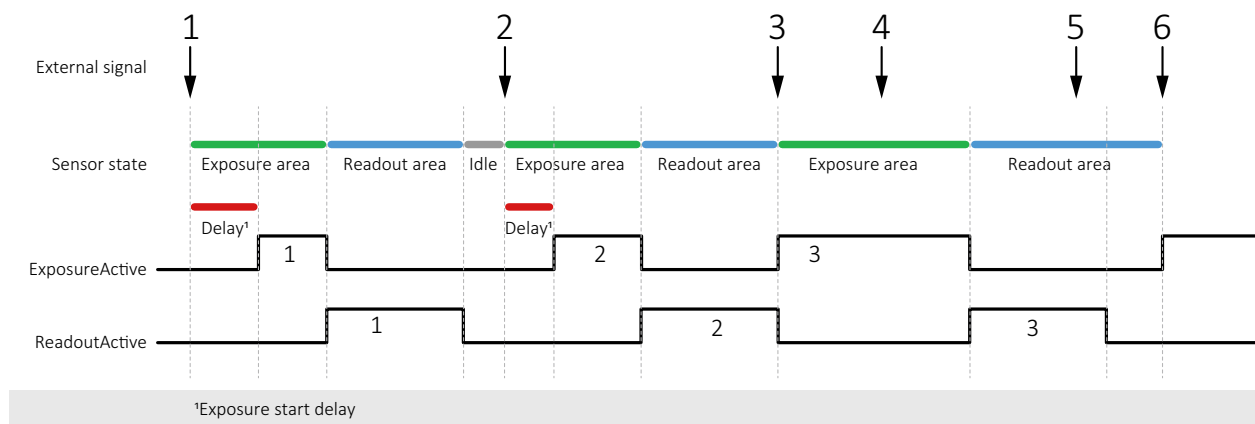

Figure 57: Triggering rolling shutter cameras

No	Conditions	Results
1	Exposure time is shorter than readout time.	Trigger 1 starts exposure 1 with a delay
2	Exposure time is shorter than readout time, but longer than for exposure 1.	Trigger 2 starts exposure 2 with a delay shorter than for exposure 1.
3	Exposure time is longer than readout time	Trigger 3 starts exposure time without a delay. Because the exposure area is longer, also the readout area is longer than for triggers 1 and 2
4	Exposure area is ongoing.	Trigger 4 is ignored.
5	Readout area is ongoing	Trigger 5 is ignored.
6	Readout area is finished. Exposure time is longer than readout time.	Trigger 6 starts exposure 6 without a delay

Table 79: Triggering results versus conditions



TriggerSelector values for rolling shutter cameras

Cameras with rolling shutter **can** be triggered using *AcquisitionStart*, *AcquisitionEnd*, or *FrameStart* for **TriggerSelector**.

Cameras with rolling shutter **cannot** be triggered using *ExposureStart* or *ExposureEnd* for **TriggerSelector**.

Ignored triggers

Alvium G1-500m/c and G1-2050m/c

Changing parameters while acquisition is active leads to ignored triggers until the parameters get active.

Trigger features and UserSetDefault

See [Trigger features and UserSetDefault](#) on page 99.

Image data flow



This chapter includes the image data flow for Alvium G1 cameras.

Figure 58 shows image data processing for Alvium G1 cameras in general.

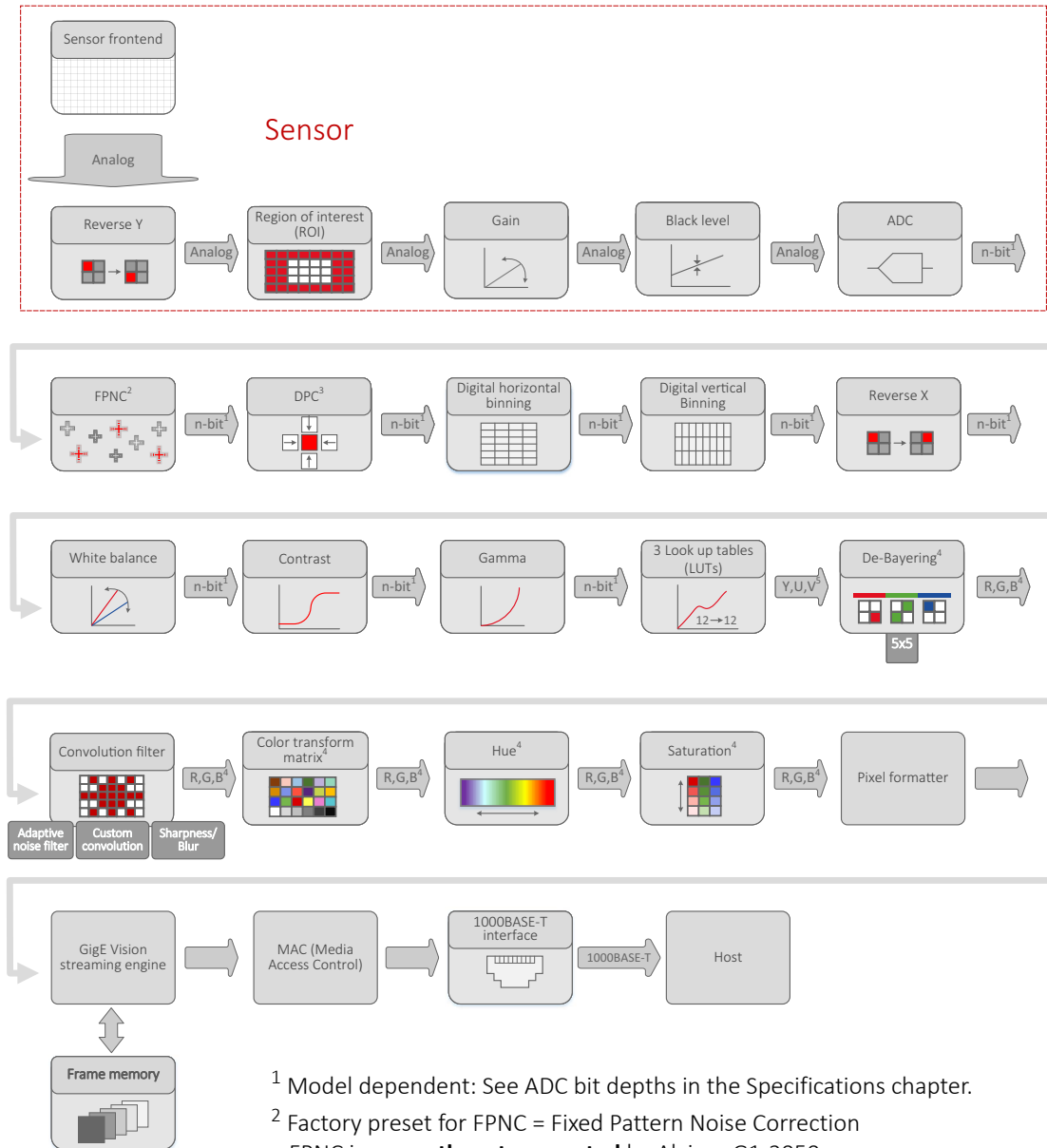

Figure 58: Image data flow of Alvium G1 cameras



Feature descriptions and firmware downloads

Alvium Features Reference: www.alliedvision.com/en/support/technical-documentation/alvium-gige-documentation

Firmware downloads: www.alliedvision.com/en/support/firmware-downloads.

Firmware update

You should update firmware only to change camera functions or fix known issues.

Consider: Any firmware update may not only add new features to a camera or fix known issues. It may also replace previous features or change camera characteristics. See firmware release notes for details.



Keep the camera connected

- Keep the camera and the computer running while you are executing a firmware update.
- If the camera is powered down during firmware update, it may get into a non-functional state. Recovery may not be possible.



Use only suitable firmware

If unsuitable firmware is used, the camera may get into a non-functional state.

- Only update to newer versions. Do not downgrade firmware to an older version, unless this has been explicitly communicated.
- We recommend updating the firmware to the next increment version only. Skipping versions may cause issues.

Firmware update with Vimba

We recommend you to install **Vimba** completely.



Vimba Driver Installer

Windows: By default, **Vimba Driver Installer** is installed as well.

1. Download and install **Vimba**.
The download includes the **Vimba Firmware Updater** and the Vimba Manual.
2. To update the firmware, follow the instructions of the Vimba Manual.



Downloads

- For Vimba, see www.alliedvision.com/software.
 - For firmware updates, see www.alliedvision.com/en/support/firmware.
3. We recommend you to use the **Vimba Firmware Updater** for easy handling. If you want to update the firmware without installing **Vimba**, please contact support at www.alliedvision.com/en/about-us/contact-us/technical-support-repair-/-rma.

If the firmware update fails,

- The camera is not recognized by **Vimba Viewer**.
- You can repeat firmware update.
- After retrying, please contact support at www.alliedvision.com/en/about-us/contact-us/technical-support-repair-/-rma.

Performance and troubleshooting



This chapter includes:

Tips and tricks to connect 1000BASE-T	143
Optimizing performance	150
Troubleshooting common issues	157

Tips and tricks to connect 1000BASE-T

This section is going to help you set up applications more easily.



Data in this section

Data in this section was adapted from the corresponding section of the Alvim G5 User Guide. General information should be correct, but some values may not be suitable for Alvim G1.



Troubleshooting

This section is covering most issues to enable proper camera operation. Should you need more help, see [Troubleshooting common issues](#) on page 157.

Hardware selection

The selection of hardware components is a key factor to minimize the risk of dropped frames. This can be achieved by such as the recommended NICs to reduce the workload for the CPU or by real-time operating systems.

All components must support the link speed required to transfer and process the data output by the camera. Otherwise, the link speed of the camera must be configured accordingly. If a part of the link on the path is under heavy load, a QoS (quality of service) can be used to ensure the needed throughput.



Recommended products

Recommendations for products are based on tests and positive experience. We plan to extend these recommendations in future.

SFP adapters

Inexpensive RJ45 / xBASE-T SFP+ modules can be used to integrate cameras in fast (Q)SFP+ or (Q)SFP28 equipment. Please check that SFP+ modules support 1000BASE-T.

NIC hardware installation

Connect NICs directly to PCIe lanes of the CPU. If the NIC is connected to the chipset, ensure that the bandwidth between chipset and CPU is sufficient. Example: A NIC and an NVME SSD connected to the chipset, can create a bottleneck between chipset and CPU.

NIC firmware and drivers

Consider updating the firmware of the NIC, if available. Use newest drivers available.

NIC driver settings



1000BASE-T mode

The 1000BASE-T mode must be enabled on some NICs and SFP modules.

In systems with more than one NUMA (non-uniform memory access) node, the interconnect between the nodes can become a bottleneck. We recommend you to optimize the settings as suggested by the CPU and NIC manufacturer. If possible, lock the host software to the NUMA node connected to the NIC.

NIC driver settings under Linux



Receive buffer size

You can increase the receive buffer size to handle the data throughput

- Temporarily: `sysctl -w net.core.rmem_max=33554432`
- Permanently: Add to the file `/etc/sysctl.conf`:
`net.core.rmem_max=33554432`

The following commands can be used to find suitable settings. Note that these settings are **only temporary**. Adjust the corresponding system configuration files to change the settings permanently.

- Enabling Jumbo frames by setting the MTU size:
`ifconfig <dev> mtu 9000`
- Setting the IP address:
`ip a a 169.254.240.4/16 dev <dev>`
- Some 1000BASE-T NICs do not support auto negotiation.
Setting the link speed manually:
`ethtool -s <dev> autoneg off speed 1000`

NIC driver settings under Windows

- Maximize the Jumbo frame size.
- Maximize the number of receive buffers.
- Switch off all non-required drivers, including filter drivers, in the network adapter settings. Mostly, the Vimba filter driver helps to increase the performance. Be aware that using a PCAP filter, such as **Wireshark**, has an impact on the performance.
- Optimize settings related to IRQs (interrupt requests) in the network driver settings (interrupt moderation).
- RSS (receive side scaling) should be enabled to improve the performance when multiple cameras or several network adapters are connected to the host.

Operation system settings

Settings under Linux

Be aware of automated network configuration tools. If configured incorrectly, these tools can periodically remove the network settings and try to find a connection to the Internet. Use a static configuration and deactivate these tools to avoid issues.

Settings under Windows

- Disable any power-management that might impact the performance, especially on NICs, PCIe or the CPU.
 - Activate **Ultimate Performance** for power plan.
 - Disable sleep modes that turn off the screen.
- Avoid unnecessary CPU and network load, also on different network adapters where no camera is connected.
- Disable antivirus software if possible.
- Avoid system events causing lost packets, such as by plugging in USB devices.

Vimba TL settings

Configuring the **Vimba** TL (transport layer) settings, can help to reduce dropped frames significantly. Look out for GenICam feature names starting with **GVSP**. Because every system is specific, individual experiments must be done.

This is an overview of GigE TL streaming features.



Transport layer descriptions and firmware downloads

Alvium Features Reference: www.alliedvision.com/en/support/technical-documentation/alvium-gige-documentation

Firmware downloads: www.alliedvision.com/en/support/firmware-downloads.

GVSPDriverSelector

GVSPDriverSelector controls which software component is used to handle the streaming.

- **Windows:** Either the stream engine of the transport layer or the filter driver is used to receive and process the GVSP packets.
- **Linux:** Only the transport layer can be used.
- **Values:**
 - *Socket*: Use of the transport layers stream engine
 - *Filter*: Use of the filter drivers stream engine

Figure 59 gives an overview of the different stream handling methods.

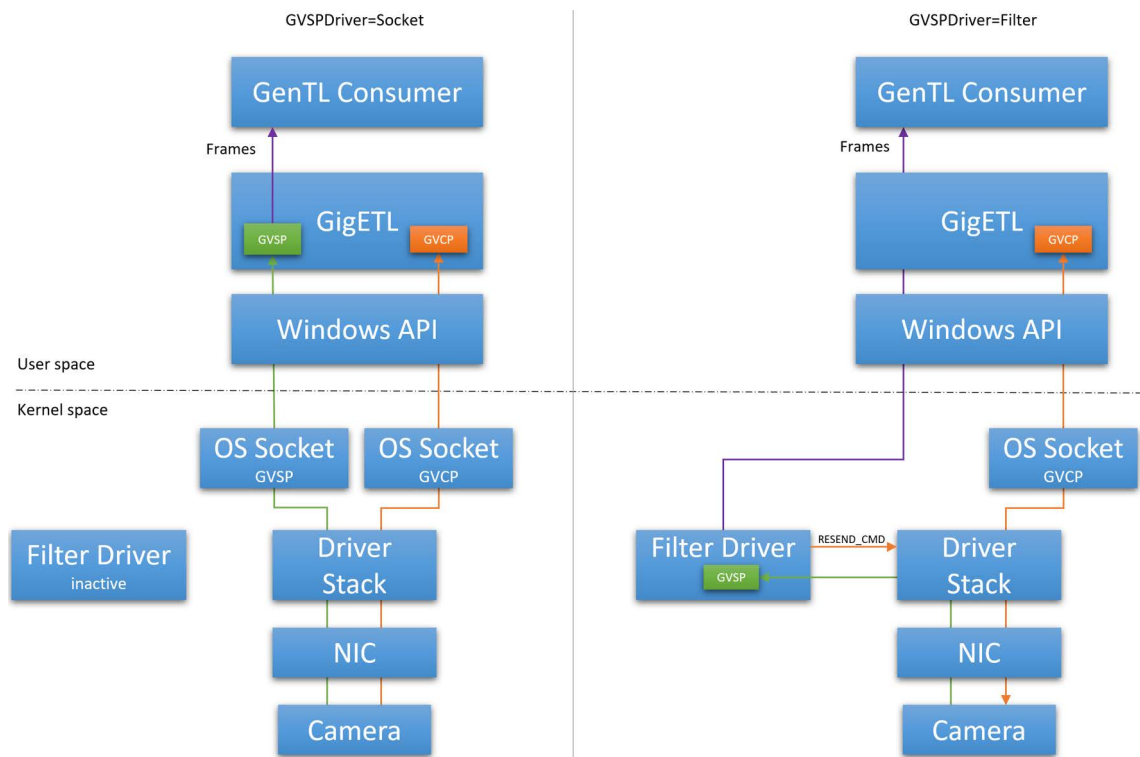

Figure 59: Stream handling with `GVSPDriverSelector` set to `Socket` or `Filter`

The filter driver minimizes the risk of lost frames substantially because it reduces the interactions between the user space and the kernel space, taking workload off the system:

When `GVSPDriver` is set to `Socket`, `GVSP` packets are processed in the user space. The downside of this approach: For each packet, system calls from the user space are required to enable `GVSP` packets pass from the kernel space.

Switching and transferring data between the kernel space and the user space is a time consuming process. This limits the number of `GVSP` packets a system can handle per second. Ensure the camera does not exceed this limit.

When `GVSPDriver` is set to `Filter`, the `GVSP` packets are processed by the filter driver that runs in the kernel space. This removes the linear dependency between system calls and `GVSP` packets. The filter driver copies the complete frame into the user space, coupling the number of system calls to the frame rate. Since the frame rate is substantially lower than the packet rate, the system has more resources left to handle the `GVSP` packets.

We recommend using the filter driver instead of the socket driver to increase performance and reliability.

If you cannot use the filter driver, you can reduce the number of `GVSP` packets per second. Increasing `GVSPPacketSize` is the only option to achieve this without reducing the performance of the camera.

GVSPPacketSize

`GVSPPacketSize` configures the total size of a GVSP packet, including the IP-, UDP- and GVSP headers.

The performance of the stream processing is largely determined by the number of received packets. [Figure 60](#) shows how `GVSPPacketSize` affects the CPU load during streaming at different packet sizes for the socket driver and the filter driver.

The diagram shows the total CPU load over all cores; on single cores, the difference between socket and driver is much larger. Values on your system may vary from values measured on our test system, but the relation is the same.

The packet size is inversely proportional to the number of packets per second. [Figure 60](#) shows that increasing the packet size reduces the number of packets, minimizing the risk of lost frames.

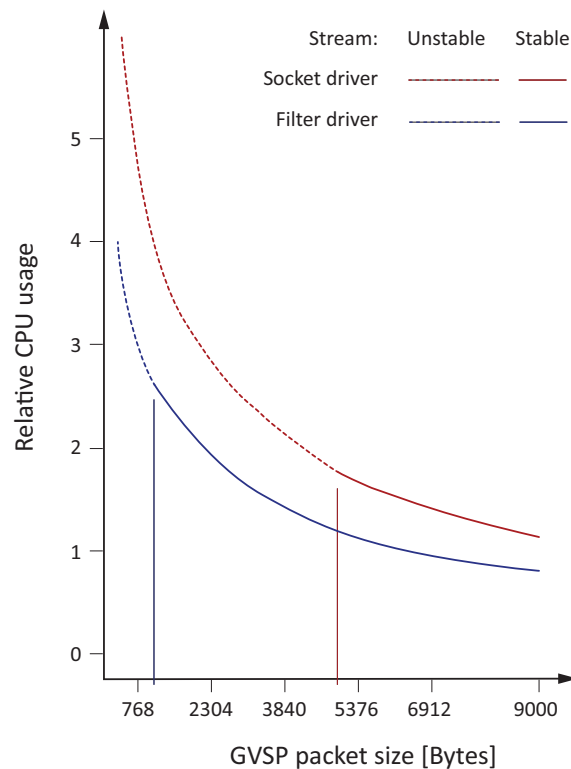

Figure 60: GVSPPacketSize versus CPU usage while the camera is streaming

Note: We recommend allowing the maximum packet size possible. To determine the maximum packet size supported by your system, the **Vimba** API includes an automatic detection: Executing the `GVSPAdjustPacketSize` command first negotiates with the camera for the best possible packet size, then automatically sets `GVSPPacketSize`.

If the detected size is 1500 Bytes or less, ensure that Jumbo Frames are enabled on the host. Jumbo Frames must be enabled on all active Ethernet components.

GVSPBurstSize

`GVSPBurstSize` configures the number of GVSP packets that are processed at once before further checks, like missing packet detection, are executed.

Note: Currently the stream performance is not significantly affected. We recommend using the default value of `1`.

GVSPHostReceiveBufferSize

`GVSPHostReceiveBufferSize` controls the socket buffer space used to receive GVSP packets. The operating system adjusts the socket buffer continuously. The value may be limited internally by the operating system. See the `SO_RCVBUF` documentation of the operating system.

Note: This feature cannot be used with the filter driver.

GVSPTimeout

`GVSPTimeout` is used to react on a possible streaming interruption. If no GVSP packet is received during the last `GVSPTimeout` milliseconds, the stream engine forces a resend of currently missing GVSP packets.



Dropped frames with certain ROIs

With certain ROIs, dropped frames may occur. This can mostly be avoided when `GVSPTimeout` is set to `1/frame rate`.

GVSPtiltingSize

`GVSPtiltingSize` is used to cancel the reception of a single frame if a certain number of GVSP packets of the following frame has already been received.

The frame is marked as incomplete and returned to the GenTL consumer.

GVSPMaxRequests

`GVSPMaxRequests` is used to configure the maximum amount of `RESEND_COMMANDS` requested for a missing GVSP packet.

Setting the feature to `0` disables the GigE Vision resend mechanism. The transport layer or filter driver does not request the re-transmission of any missing GVSP packet.

GVSPMissingSize

`GVSPMissingSize` is used to cancel the reception of a single frame if the resend limit `GVSPMaxRequests` is reached for too many packets.

The frame is marked as incomplete and returned to the GenTL consumer.

Configuring the resend behavior

`GVSPMaxLookBack` and `GVSPMaxWaitSize` can be used to configure the "timing" of `RESEND_CMDs`.

GVSPMaxLookBack

`GVSPMaxLookBack` can be used to delay the first `RESEND_CMD` for a missing GVSP packet by X packets.

GVSPMaxWaitSize

`GVSPMaxWaitSize` can be used to delay the `RESEND_CMD` for the same missing GVSP packet. The transport layer or the filter driver waits until `GVSPMaxWaitSize` of packets has been reached before requesting a resend for the same packet again.

Example:



`GVSPMaxLookBack = 1` | `GVSPMaxWaitSize = 2` | `GVSPMaxRequests = 2`

Figure 61: Controlling the resend of packets

Optimizing performance

Image transfer with rolling shutter cameras

Alvium G1-500m/c and G1-2050m/c

If acquisition is started and stopped in a short sequence, no image is transferred to the host. The duration cannot be predicted, because it depends on various factors.

Frame rate jitter

Alvium G1-500m/c and G1-2050m/c

Generally, some parameters can be changed during exposure without affecting the timing. For models with ON Semiconductor AR sensors and rolling shutter sensors, a different behavior must be considered for **camera operation in freerun mode without triggering**:

Changing parameters during exposure leads to frame rate jitter. When parameters are entered, the next frame starts only after readout and sensor reconfiguration delay are finished. When the camera is run in **ExposureAuto** mode, the actual frame rate is less than the calculated value for the corresponding exposure time. Consider frame rate jitter for your application, including a gap between **ExposureActive** signals.

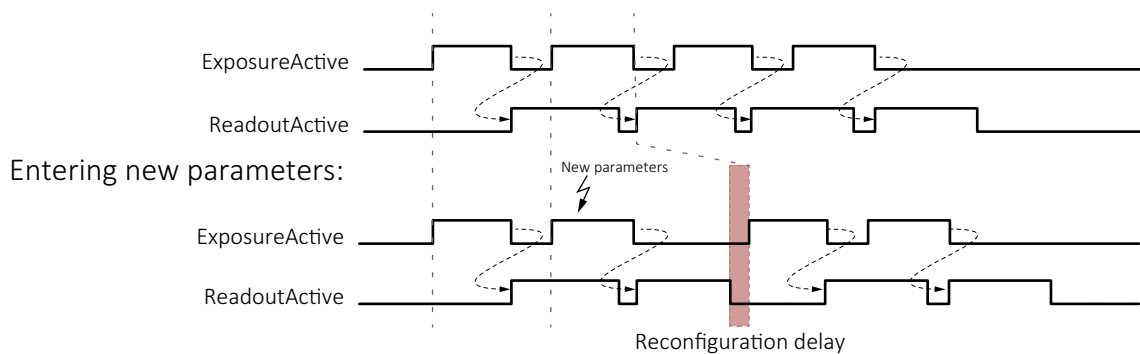

Figure 62: Delayed exposure due to parameter changes



Parameter changes in triggered mode

See [Ignored triggers](#) on page 138 for more information.

Value changes by feature interdependencies

The conversion between time and clock cycles affects control values. Features for pixel format, bandwidth, ROI, exposure time, and triggering are related to each other. Changing values for one feature can change values for another feature. For example, frame rates can be reduced when `PixelFormat` is changed subsequently. [Figure 63](#) shows the interdependencies.

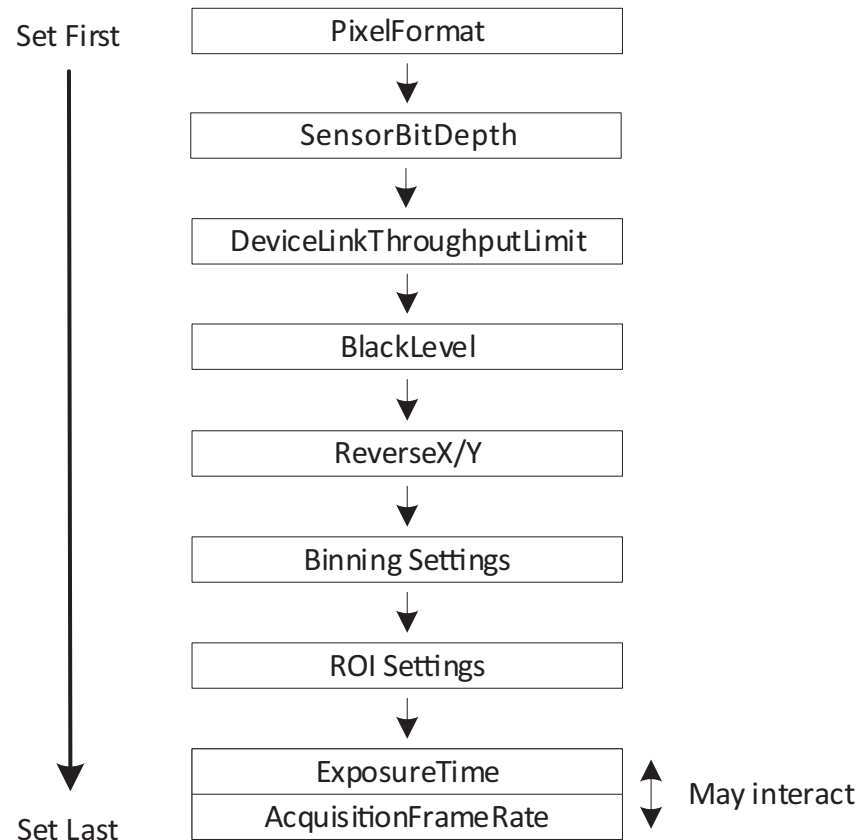

Figure 63: Interdependencies between features

Effects for the interdependent features

Changing one control's value affects other control's values, such as:

If: `Height` value is changed.

Then: Other values may be affected, such as for `AcquisitionFrameRate` and `ExposureTime`.

We recommend you to consider:

- The more features you adjust, the more current values deviate from previously set values.
- The same effects that apply to `ExposureTime`, also apply to `AutoExposure`.
- To avoid readjustments, apply settings in the order shown in [Figure 63](#).

Impact by other features

Input	Output	
	Exposure time values	Frame rate
AcquisitionFrameRate	Not affected	Affected
ExposureTime	Affected as expected	Affected
DeviceLinkThroughputLimit	Affected	Affected
Height	Not affected	Affected
Width	May be affected	May be affected

Table 80: Impact by other features

Exposure times and frame rates with Sony IMX rolling shutter cameras

Alvium G1-2050m/c

Generally, long exposure times result in low frame rates because one is roughly the inverse of the other. For Alvium G1 cameras with Sony IMX RS sensors:

- The range of available frame rates depends on the exposure time.
- The exposure time must be increased when low frame rates are used.
- The available range for frame rate values depends on the exposure time. If by changing the exposure time, the previous frame rate is moved out of the available range, the frame rate is adjusted automatically.

Dark current compensation

All sensors accumulate dark current in the pixels. Dark current increases the signal level and black level. Most sensors in Alvium G1 cameras compensate for this.

If cameras are operated at high temperatures or long exposure times, compensation reaches its limits. The typical compensation mechanism uses a **margin** to compensate for dark current. This works only until dark current reaches the size of the margin. The following table shows the relation of the margin and accumulated dark current for a pixel in 8-bit mode with a maximum value of 255.

Effective signal versus noise	Description
	The pixel has accumulated no dark current, the margin has maximum size.
	The pixel has accumulated some dark current, reducing the size of the margin.
The following images show a pixel that has accumulated a higher dark current than the margin.	
	The pixel has accumulated dark current, the margin reduces to 0. <ul style="list-style-type: none"> • Dark current compensation stays active. • Maximum saturation signal decreases. • Fixed pattern noise increases. This sensor-internal compensation is typically used in the analog domain.

Table 81: Accumulated dark current affecting the effective image signal

Additional compensation

If compensation limits are reached and you cannot decrease operating temperature or exposure time, what can you do to keep signal quality high?

You can increase the margin size by using gain, with the following side effects:

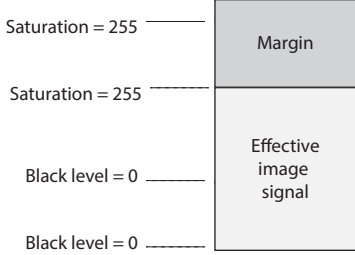
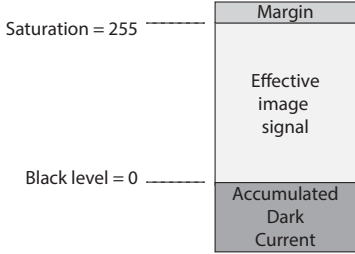
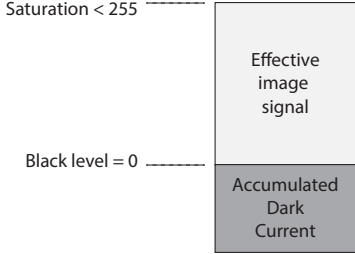
- To give space to a larger margin, the effective pixel capacity decreases.
- White and light gray values are shifted down to gray.

Shutter types affecting image readout

Some Alvium G1 camera models are operated using global shutter (GS):

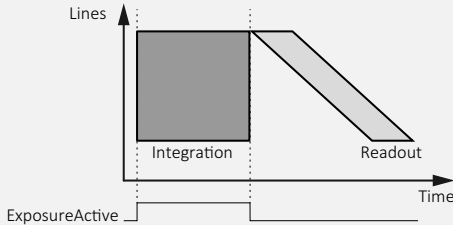
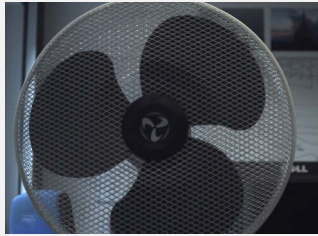
Property	Line readout	Moving image
Global shutter (GS)		

Other models use rolling shutter (RS). Alvium G1-2050 models with Sony IMX183 sensor offer global reset shutter (GRS) in addition:



Property	Rolling shutter (RS)	Global reset shutter (GRS)
Line readout		
Line exposure start	Deferred from line to line	Common for all lines
Line exposure time	Common for all lines	Increases from line to line
Image acquisition of moving objects		
Image brightness	Constant over the image	Varying over the image
Moving objects	Distorted shape	Shape without distortion
Typical application	Static objects	Moving objects
Compensation	Use an additional mechanical shutter or use a strobe light:	
		

Table 82: Shutter types affecting image readout

Operating systems and bandwidth

If the camera data output exceeds the bandwidth supported by the host computer, images may be corrupted. This section gives some background information to enable proper image transfer.

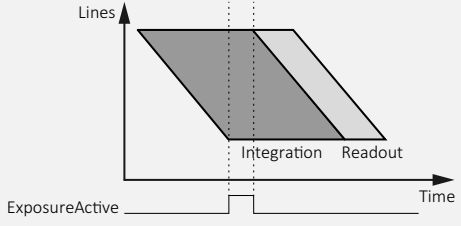
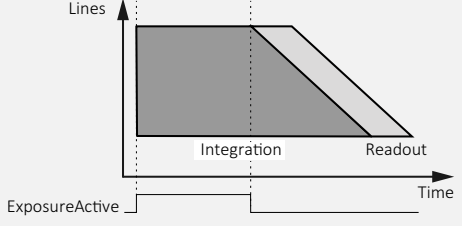
Sensor data output and camera data output

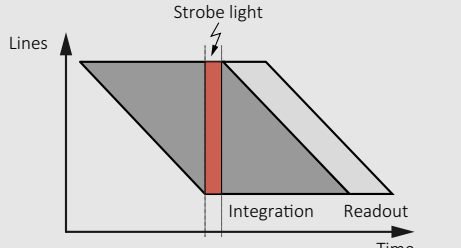
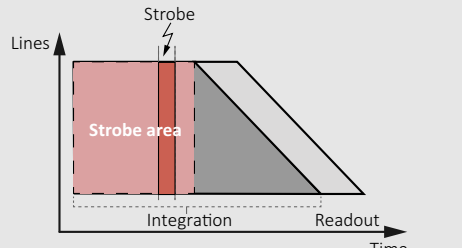
For cameras with an image buffer, the required bandwidth for image acquisition can be estimated for a given frame rate, pixel format, and resolution by over-the-thumb calculations.

Figure 64 shows the bandwidth for a higher (1) and a lower (2) value for `DeviceLinkThroughputLimit`.

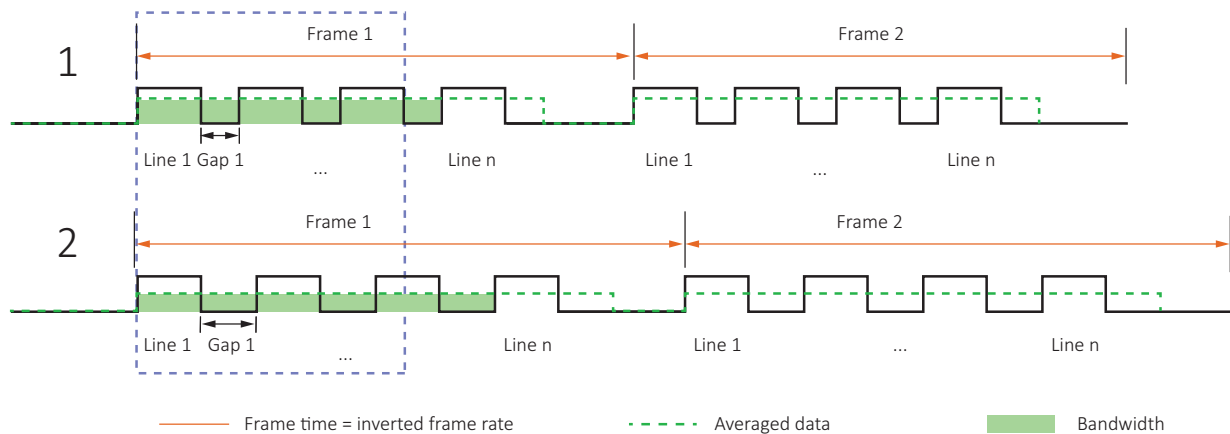

Figure 64: Sensor data output and camera data output

- Cameras **without** an image buffer like Alvim G1: Data is averaged over the line time.
- Cameras **with** an image buffer: Data rate is averaged over the frame time.
- Using `DeviceLinkThroughputLimit`: Reduces the maximum line data rate.

`DeviceLinkThroughputLimit` controls the maximum bandwidth of the data streamed out by the camera. When the value for this feature is reduced, the gaps between the lines are increased. This reduces the frame rate and therefore the bandwidth.

Additionally, you may reduce the frame rate to reduce bandwidth.

Consider that **Vimba Viewer** does not gray out values that exceed the bandwidth supported by the host computer.



Feature description for `DeviceLinkThroughputLimit`

For a description of this feature, see the Alvim Features Reference: www.alliedvision.com/en/support/technical-documentation/alvim-gige-documentation.

Hardware and bandwidth

For a smooth data transfer of Alvium G1 cameras, the host computer must be equipped with a high-bandwidth 1000BASE-T compliant NIC. We recommend using direct point-to-point links from camera to NIC for best performance.

Vimba settings

During freerun, Alvium G1 cameras do not automatically adapt the frame rate to the limits of your system, including the NIC. If the data rate is too high, it receives corrupted frames. The image transfer status in **Vimba Viewer** is signaled as **Running**. However, the corrupted frames are not displayed. For a solution, see [Camera cannot acquire images](#) on page 158.

Troubleshooting common issues

Camera is not powered

Camera or system issue?

When the camera is connected, the [Status LEDs](#) signal the camera status. If the LEDs of a connected camera are not illuminated, check with a working camera.

Power supply

If using a custom power supply, ensure that

- The adapter and wire gauge are rated 1 A at 12 VDC (lower current for higher voltages).
- The TFM connector is supplied with minimum 10.8 VDC despite voltage drop across the cabling.

Camera is not detected in the viewer

The camera is powered correctly, but it is not detected in the viewer.

Ethernet cabling

Damaged or poor quality Ethernet cabling can result in no cameras found, dropped packets, decreased bandwidth, and other problems. Use Category 6 or higher rated Ethernet cabling.

NICs and NIC ports

NICs or Ethernet adapters using Intel I219-LM chipset may not activate the link when an Alvium G1 camera is connected directly. As a workaround, connect the camera to a different network adapter.

Ethernet adapter settings

Return to [Modifying the NIC IP address](#) on page 121, which describes how to adjust the IP address of the host adapter. Do not use gateways on your NIC. Connect a single camera directly to your NIC.

Ensure that IP address of the adapter is on the same subnet as the camera. If not, return the adapter address to the Auto IP configuration. A sample IP configuration for the camera and adapter is shown below.

	Adapter	Camera
IP address	169.254.23.2	169.254.43.3
Subnet mask	255.255.0.0	255.255.0.0

Table 83: Sample IP configuration

Camera cannot acquire images

The camera is detected in the viewer but does not acquire images.

Revert the camera settings to factory default: In the controller window of **Vimba Viewer**, under *SavedUserSets*, set *UserSetDefaultSelector = Default*, click *UserSetLoad*, and click the *Execute* button.

If StatFramesDelivered / StatPacketsReceived = 0

- Click on *Stream > Statistics* to view camera freerun statistics.
- Disable your firewall on Ethernet adapter connected to camera to avoid blocking incoming traffic.
- Ensure that in **Vimba Viewer**:
AcquisitionFrameRateEnable = True
TriggerSelector = FrameStart
TriggerSource = Software or *LineX*
- Consider that some trigger modes require a trigger event to capture frames.

If StatFramesDropped ≠ 0

Packets are incoming, but all dropping.

Enable Jumbo Frames on your adapter, see [Adjusting the NIC driver settings](#) on page 122.

If StatFramesDelivered value increases, but images are black

- Ensure your scene is sufficiently lit.
- Increase the exposure time value, using *ExposureTimeAbs*.
- Ensure the lens is properly installed and the lens cap has been removed.



If you are still having problems, please contact support at www.alliedvision.com/en/about-us/contact-us/technical-support-repair/-/rma.

Avoiding dropped packets

- Check the Ethernet cable. A damaged cable often causes the link to negotiate a lower speed as fallback.
- **Windows:** Disable auto updates and telemetry.
- Use the latest NIC driver from the NIC manufacturer.
- Enable Jumbo Frames/Packets on the NIC. Larger packets result in less overhead on the host CPU. See [Enabling Jumbo Packets](#) on page 122.



Available packet size

Be aware that the effective maximum packet size is limited to the biggest size supported by all network devices on the path.

- Disable the firewall if no filter driver is used.
- If possible, use a dedicated network infrastructure:
 - Ideally, each camera has a point-to-point connection to a dedicated network adapter in the host.
 - Separate camera networks from other networks.
 - Avoid aggregating multiple cameras over a single network link if possible. The more cameras use a common link, the lower becomes the usable total system throughput, caused by packet losses or less effective processing on the host side.
- **Linux only:** Run as root, allowing the OS to boost the priority of the Allied Vision driver thread, and the driver to bind directly to the NIC adapter. Users who feel running as root compromises their system security may find the following implementation satisfactory:
 - Set the executable owner as root.
 - Set the “setuid” permission bit on the executable.
 - In code, when application starts use `capset()` to release all but these privileges: `CAP_SYS_NICE`, `CAP_NET_ADMIN`, `CAP_NET_BROADCAST`, `CAP_NET_RAW`. The application will start with all root privileges, but it will drop them immediately after startup.

Index

A

AcquisitionActive	136
Auto IP configuration	157

B

back panel	127
------------------	-----

C

camera connectors	127
camera hardware	125
camera mounting	114
Category 6	123, 157
connectors	125
copyright	30
current and voltage	33

D

dark current compensation	153
digital binning	45
dimensions	92
document	
conventions	24
history	22
overview	14

E

ESD	33
-----------	----

F

FCC	28
feature availability	100
firmware update	141
frame rates > reference settings	43

G

general safety notes	30
GenICam	38
GigE Vision	38
global reset shutter (GRS)	154
global shutter (GS)	154

H

heat dissipation	31
heat sink mounting	113
host computer	
configuring	120
connecting	123

connecting 1000BASE-T	143
Jumbo Packets	122
NIC driver installation	120
NIC driver settings	122
NIC IP address	121

I

I/Os, GPIOs	
connector pin assignment	128
description	129
image data flow	139
interfaces	125
IP class	38
IR cut filter	96

J

Jumbo Packets	122
---------------------	-----

L

lens	
focal length vs. FOV	102
maximum protrusion	36, 95
mounting	116
mounts	95
vignetting	103

M

mass	92
------------	----

N

NIC	
safety	34
troubleshooting	157

P

power consumption > reference settings	45
powering up the camera	124

R

readout modes	42
ROI frame rates	42
rolling shutter (RS)	154

S

safety	2, 4, 13, 24, 31
camera power	33
electrical connections	33
heat dissipation	31
heavy lenses	32
lens mounts	31
lens protrusion	36
mounting cameras	32

NIC	34	troubleshooting	142
optical components	35	bandwidth	155
sensor	35	dark current compensation	153
sensor ADC readout modes	42	dropped packets	159
sensor position accuracy	97	feature interdependencies	151
sensor shutter types	44	frame rate jitter	150
shock and vibration	38	troubleshooting common issues	157
specifications	37	U	
standards applied	38	user sets	99
status LEDs	134	V	
T		vignetting	103
technical drawings	92	W	
torque values	114	white balance default	91
trigger latency	136		
trigger signal flow	136		
triggering with RS cameras	137		