

NOTES:

1. SUBSTRATE:
Fused Silica (Corning 7980)
2. SURFACE S2 TO BE PARALLEL WITH S1 TO <1 arcmin
3. COATING (APPLY ACROSS CLEAR APERTURE)
S1 & S2: NONE
4. FINE GRIND SURFACE
5. RoHS COMPLIANT

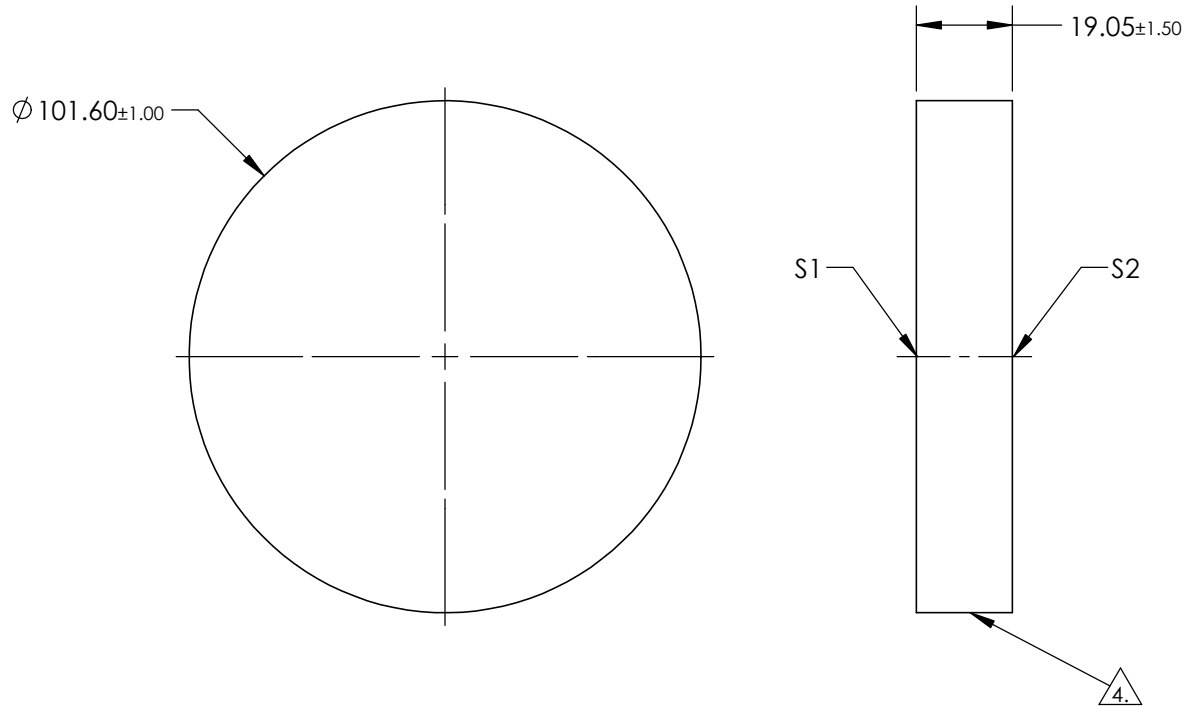

**FOR INFORMATION ONLY:
DO NOT MANUFACTURE
PARTS TO THIS DRAWING**

SPECIFICATIONS SUBJECT TO CHANGE WITHOUT NOTICE
DIMENSIONS ARE FOR REFERENCE ONLY

	S1	S2
SHAPE	PLANO	PLANO
SURFACE FLATNESS	$\lambda/20$	$\lambda/20$
SURFACE QUALITY	60-40	60-40
CLEAR APERTURE	$\varnothing 91.44$	$\varnothing 91.44$
BEVEL	PROTECTED AS NEEDED	PROTECTED AS NEEDED

THIRD ANGLE PROJECTION

ALL DIMS IN

mm

Edmund Optics®

TITLE

4" Dia. $\lambda/20$ Fused Silica Dual Surface Flat

DWG NO

48132

SHEET
1 OF 1